

中文 | ENGLISH

无轴承磁编码器系统 MAG(A)

安全、灵活、可靠、定制

Bearing-free magnetic encoder systems MAG(A)

Safe, flexible, reliable, tailor-made



目录

Contents

任务和解决方案	3
产品的优点	4
工作原理	6
脉冲轮	8
扫描头	11
应用聚焦	12
应用实例	13
安装情况和附着解决方案	16
可选项	18
技术参数	19

Task and Solution	3
Product benefits	4
Operating principle	6
Pulse wheels	8
Scanning heads	11
Application focus	12
Application examples	13
Installation situations and attachment solutions	16
Options	18
Technical data	19

精确、优势、关注客户

我们专注于技术— 我们了解我们的客户。我们坚定的站在客户一边为其提供特殊的设想、定制的解决方案。为了支持我们的客户，我们提供了强大的编码器系统、强大的传动技术和全球化的服务。我们将与我们的客户一起克服在重工业领域或其它极其恶劣条件领域的巨大的挑战，继而不断的增进客户的业务。你有什么挑战？

Precision. Strength. Customer focused.

We are fascinated by technology – and we understand our customers. We stand firmly at your side with exceptional ideas and tailor-made solutions; to support our customers we offer robust encoder systems, powerful drive technology and a worldwide service. That is how we overcome together with our customers the huge challenges in heavy industry and other fields subject to harsh conditions to sustainably improve their business. What challenges do you have?

我们的应用领域：

- 金属及轧制技术
- 港口和起重机技术
- 矿山工业
- 石油和天然气工业
- 运输
- 海洋工程
- 发电行业
- 其它应用领域

Our fields of applications:

- Metal and rolling mill technology
- Harbour and crane technology
- Mining industry
- Oil and gas industry
- Transport
- Marine engineering
- Power generation
- ... and many other applications

任务和解决方案

Task and Solution

任务

重工业需要编码器解决方案，提供长期可靠的过程控制信号这是在面对由机械冲击、振动、极端温度、灰尘、污垢和液体等重负荷造成的最恶劣条件时所需要的。每一次计划外停机都会造成很巨大的生产损失。

应用领域不是不适合，就是根本不可能安装带有光学扫描的编码器。原因通常可以在安装的情况下找到，例如：极其有限的空间、没有自由轴端或轴直径大，以及过大的轴向位移和/或径向轴偏心。

Task

The heavy industry demands encoder solutions which deliver reliably process control signals over many years. This is required in the face of the harshest conditions resulting from heavy loads such as mechanical shock, vibration, extreme temperature, dust, dirt and fluids. Each and every unplanned downtime causes high production losses.

Applications in the field are either unsuited or it is simply not possible to fit encoders with optical scanning. The reasons are generally to be found in installation situations, for example extremely confined spaces, no free shaft end or large shaft diameters. And that in conjunction with excessive axial and/or radial shaft excentricity.



解决方案

Johannes Hübner Giessen 拥有在全球重工业安装成千上万应用的经验，是真正的重载制编码器解决方案的专家，现在提供了以其模块化、无轴承磁编码器系统 MAG 的理想的解决方方案。

MAG 是:

- 安全
- 灵活
- 可靠
- 可定制

Solution

With the experience of installing thousands of applications in heavy industry across the globe Johannes Hübner Giessen, the specialists for genuine heavy duty encoder solutions, now offers the ideal solution in form of its modular, bearing-free magnetic encoder system MAG.

MAG is:

- safe
- flexible
- reliable
- tailor-made

产品的优点/Product benefits

安全性/safe

- 高精度信号通过特别多重扫描
- 具有较强的机械能力，能适应重载安装设备
- 每个应用任务的离心力和抗疲劳性计算
- 在工厂的试验台上进行速度和抗疲劳试验
- 特殊的脉冲轮设计，高速范围
- High-precision signal through special multiple scanning
- Robust mechanics capable with heavy duty fixing equipment
- Centrifugal force and fatigue resistance calculations for each application task
- Speed and fatigue resistance tests performed on own test stand
- Special pulse wheel designs for high speed ranges

灵活性/flexible

- 模块化概念使定制解决方案成为可能
- 适用于直径高达 1500 mm 的轴
- 适用于有或无自由轴端的安装
- 分瓣脉冲轮—改造项目的理想选择
- 适用于高速
- 适用于大轴向窜动的超宽系统
- 用于安装空间极为有限的超薄系统
- 输出信号种类繁多（增量、绝对值、限速、光缆等）
- Modular concept enables customized solutions
- Suitable for shaft diameters up to 1500 mm
- Suitable for installations with or without free shaft end
- Split pulse wheel – ideal for retrofit projects
- Suitable for high speed
- Extra-wide systems for large axial shaft eccentricity
- Extra-slim systems for extremely restricted installation spaces
- Wide variety of output signals (incremental, absolute, limited speed, fiber optic cable, etc.)

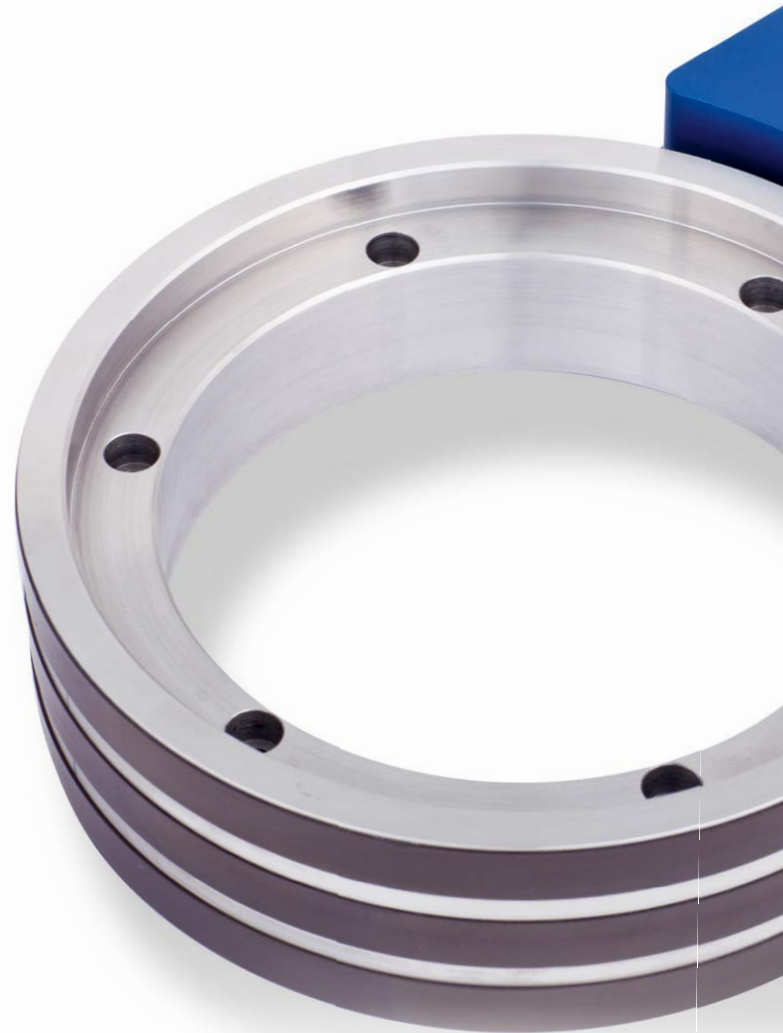

产品的优点/Product benefits



可靠性/reliable

- 对机械冲击、振动、灰尘、液体和碎片等外部影响具有极高的抵抗力
 - 坚固的、封装在特殊的重载外壳中的电子部分
 - 可选配脉冲轮盖，用于磁道的额外保护
 - 无接触、无轴承技术，无机械磨损
- 由于长寿命和最大限度的工厂可用性，非常经济。
- Extremely high resistance to external influences such as mechanical shock, vibration, dust, liquids and chips
- Robust, encapsulated electronics in special heavy duty housings
 - Optional pulse wheel cover for additional protection of magnetic tracks
 - Contact-free and bearing-less technology meaning no mechanical wear
- Extremely economic thanks to long lifetime and maximized plant availability

可定制/tailor-made

独特的服务提供编码器项目 8 个步骤:

- 记录现场安装情况
 - 在工厂进行技术澄清
- 准备草图并提出解决方案
 - 按合同规定设计和计算
- 磁编码器和机械部件的制造
- 磁编码器交付，包括所有附件
- 按要求组装完整的磁编码器系统
 - 售后服务和特殊问题咨询

Unique service offer for encoder projects in 8 steps:

- Recording the installation situation on site
 - Technical clarification at the plant
- Prepare sketches and propose solutions
 - Contract-specific design and calculation
- Manufacturing of magnetic encoders and mechanical components
- Delivery of magnetic encoders including all accessories
 - Assembling the complete magnetic encoder system on request
- After-sales service and consultation on special questions

工作原理/Operating principle

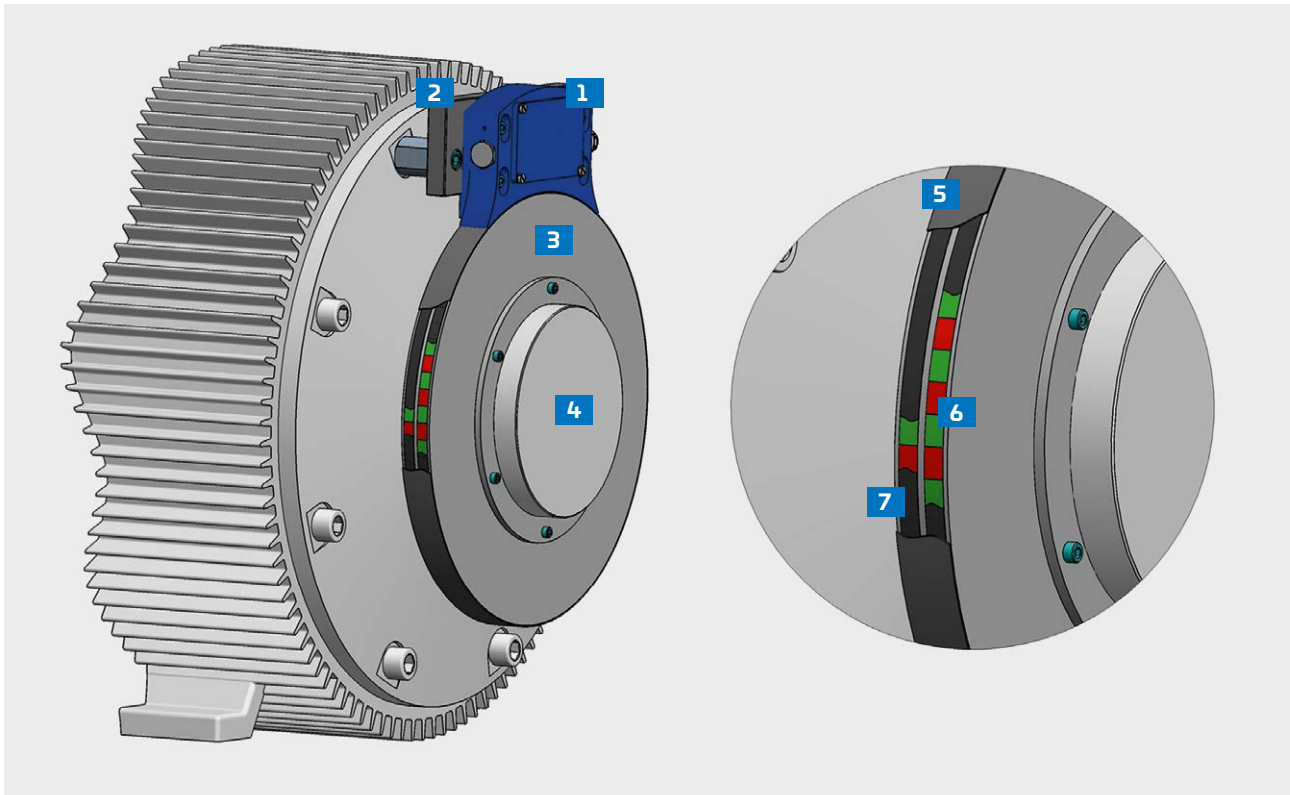

磁编码器系统包含扫描头和脉冲轮

- 1 扫描头防护等级高达 IP68
- 2 扫描头支架
- 3 脉冲轮
- 4 电机轴
- 5 磁道的保护
(碳纤维 / 不锈钢保护罩)
- 6 基本通道
- 7 参考脉冲通道

该测量系统存在一个磁硬载体（脉冲轮）带有标记的磁分区（南北磁极），可采用特殊的防护盖保护，以防止环境影响。传感器和电子部分安装在单独的扫描头中。

Magnetic encoder system existing of scanning head and pulse wheel

- 1 Scanning head up to IP68
- 2 Scanning head support
- 3 Pulse wheel
- 4 Motor shaft
- 5 Magnetic track protection
(CFRP/stainless steel protection cover)
- 6 Basic channel
- 7 Reference pulse track

The measurement system exists of a magnetically hard carrier (pulse wheel) with marked magnetic partition (north-south poles), which can be protected by a special protection cover against the effects of environmental influences. The sensors and electronics are housed in the separate scanning head.

产品信息 / Product details



扫描头与脉冲轮廓精确匹配

Scanning head and pulse wheel contours precisely harmonized



通过应用优化安装的脉冲轮和扫描头，非常耐重型环境中的负载。

Extremely resistant to loads in heavy duty environments by application optimized mounting of pulse wheel and scanning head



分瓣脉冲轮的精准连接，实现无间隙过渡和高质量信号

Precise connection of split pulse wheels for gap-free transition and very high signal quality

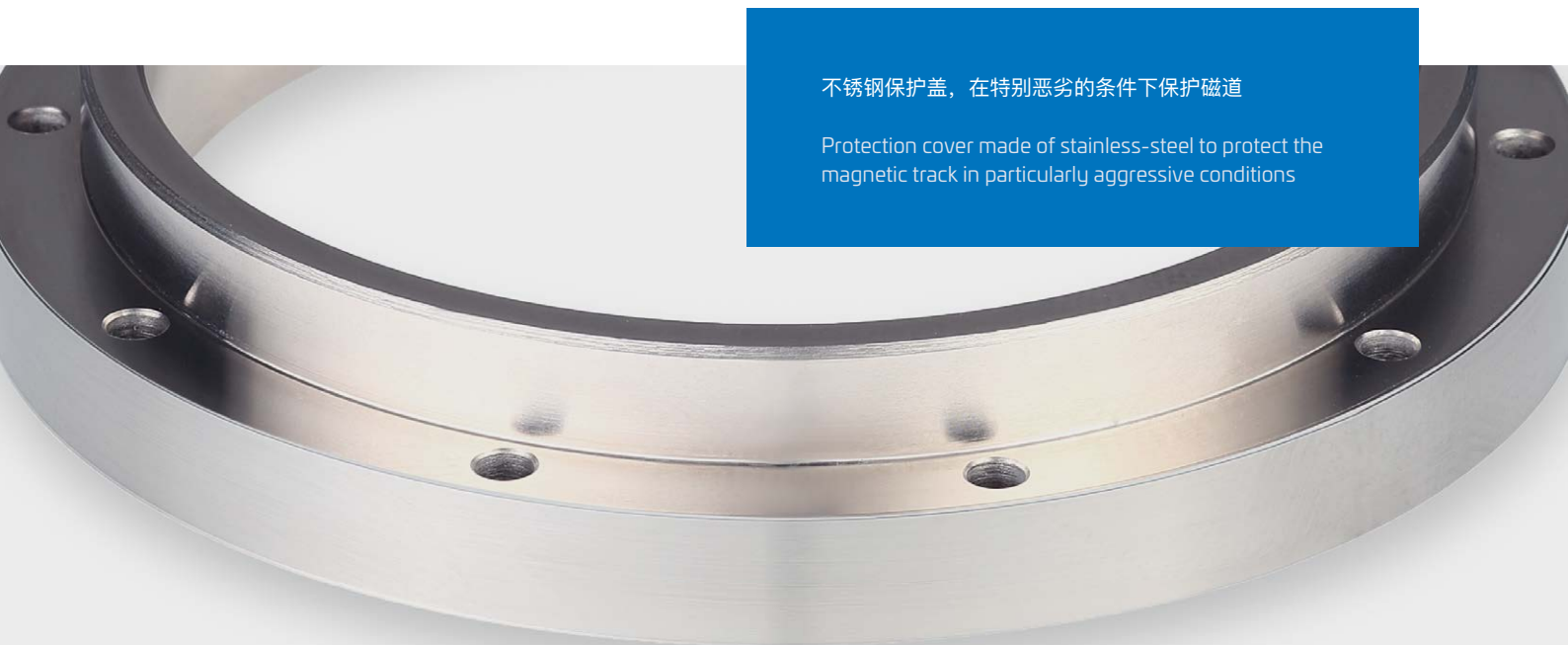

不锈钢保护盖，在特别恶劣的条件下保护磁道

Protection cover made of stainless-steel to protect the magnetic track in particularly aggressive conditions



脉冲轮/Pulse wheels

Hübner Giessen 公司的磁编码器系统具有无可比拟的性能，根据客户的特殊要求生产脉冲轮，轴颈在 20 毫米到 1500 毫米之间。分瓣脉冲轮是完美的解决方案，能简单的安装在没有自由端的应用。

Hübner Giessen's MAG system offers unrivalled flexibility with pulse wheels manufactured to individual customer specifications for shaft diameters between 20 and 1500 mm. Split pulse wheels are the perfect solution to enable simple installation in applications without a free shaft end.



MAG 优势

- 非常灵活，适应任何的安装情况
- 防尘、防污、抗外部磁场和抗液体和冷凝水（可在介质中操作）
- 保护等级高，并能抵抗机械冲击和振动
- 无机械磨损
- 适用于高速

MAG advantages

- Extremely flexible thanks to specific adaptation to any installation situation
- Resistant to dust, soiling, external magnetic fields as well as fluids and condensation (operation possible in media)
- High degree of protection as well as resistance to mechanical shock and vibration
- No mechanical wear
- Suitable for high speed



脉冲轮/Pulse wheels

使 MAG 适应于应用环境始终是最重要的。超薄脉冲轮适用于极窄的空间。MAG 系统提供非常宽的磁道，以适应高达 ± 8 mm 的轴向窜动。所需的输出信号决定了磁道的数量。

The adaption of the MAG to the application situation is always in the foreground. Slim pulse wheels are suitable for extremely narrow spaces. The MAG system offers extremely wide track widths to accommodate axial shaft movements up to ± 8 mm. The desired output signal determines the number of tracks.



单磁道脉冲轮用于增量信号

Single track pulse wheel for incremental signals



双磁道脉冲轮用于增量信号与标志脉冲信号

Two track pulse wheel for incremental signals with additional reference pulse



三磁道脉冲轮用于绝对值信号 可选项：增量信号

Three track pulse wheel for absolute signal
Option: incremental signals



四磁道脉冲轮用于绝对值、增量信号与标志脉冲信号

Four track pulse wheel for absolute and incremental signals with additional reference pulse



分瓣脉冲轮 / Split pulse wheels

使用分瓣脉冲轮意味着在没有自由轴端的安装情况下，不需要进行大量的安装和拆卸工作。因此，当编码器需要集成到现有设备时，分瓣 MAG 系统特别适合于改造和升级项目。

Utilizing a split pulse wheel means extensive installation and removal work is not necessary in application situations where no free shaft end is available. As a consequence, the split MAG system is particularly suitable for retrofitting and upgrade projects when the encoder needs to be integrated in an existing plant.



两个脉冲轮部件用螺钉连接在一起，或者夹在轴上，或者夹在轴肩或单独的定心环上。Hübner 的分瓣磁编码器具有专利、积极的设计，适用于高速运行的应用

The two pulse wheel parts are joined together with screws and either clamped on the shaft or affixed at a shaft shoulder or a separate centering ring. Hübner offers the split MAG system with a patented, positive-fit design for applications operating at particularly high speeds.

扫描头/Scanning heads

MAG 扫描头可根据客户的要求提供多种输出信号：HTL, TTL, sin/cos, SSI, EtherCAT 等接口。可以通过铜或光缆传输增量信号。MAG系统提供多种连接选项：端子箱、固定电缆、12 针圆接头或定制解决方案。

可以在一个脉冲轮上使用多个扫描头来实现多功能系统解决方案。

MAG scanning heads offer a variety of output signals: HTL, TTL, sin/cos, SSI, EtherCAT and other interfaces on request. It is either possible to transmit the incremental signals via copper or fiber optic cables. The MAG system offers several connection options: terminal box, fixed cable, a 12-pin round connector or customized solutions.

It is possible to use several scanning heads at one pulse wheel to realize multi-functional system solutions.



扫描头带铜或光缆接线端子箱

Scanning head with terminal box for copper or fiber optic connection

扫描头带有 12 针圆接头

Scanning head with 12-pin round connector

微型 MAG 扫描头带直出电缆

Mini MAG scanning head with fix connected cable

应用关注 / Application focus

- 特别设计的重载应用，编码器面临来自机械冲击、振动、温度变化的潮湿的极端负载
- 在狭窄空间中的应用
- 设计没有自由的轴端
- 大轴直径（1500 mm 以下）的电机或发电机
- Specially designed for heavy duty applications in which encoders are faced to extreme loads resulting from mechanical shock, vibration, temperature changes and moisture
- Applications in narrow spaces
- Designs without a free shaft end
- Motors/generators with large shaft diameters (up to 1500 mm)



应用实例 / Application examples

应用 / Application	轧机用串联电机	Tandem motors in rolling mill
安装情况 / Installation situation:	轴肩上没有自由端	No free shaft end with shaft shoulder
编码器方案 / Encoder solution:	MAG-G 带分瓣脉冲轮	MAG-G with split pulse wheel
安装 / Mounting:	拧紧到轴肩	Screwed at shaft shoulder
特点 / Special features:	在不拆除安装的情况下进行改造	Retrofit without dismantling of installation



串联电机之间的连接轴上无自由轴端
No free shaft end at connection shaft between tandem motors

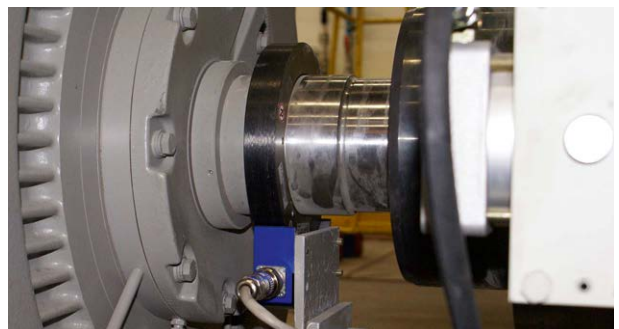

由于脉冲轮分瓣，改造无需拆卸安装
Retrofit without removal of installation due to split pulse wheel

应用 / Application	冷轧测量辊	Measuring rolls in cold rolling mill
安装情况 / Installation situation:	用脉冲轮替代法兰	Replacement of flange with pulse wheel
编码器方案 / Encoder solution:	MAG	MAG
安装 / Mounting:	脉冲轮作为辊道盲板法兰	Pulse wheel as blank flange of the roll
特点 / Special features:	超薄设计 (10 mm)，极端环境影响	Very slim design (10 mm), extreme environmental influences



极度狭窄的空间需要超薄的设计
Extremely confined spaces demand an extra-slim design



在极端的环境下具有可靠的功能
Reliable functionality in extreme environmental influences

应用实例 / Application examples

应用 / Application	起重机 起升装置	Crane hoist
安装情况 / Installation situation:	没有轴肩上自由端	Free shaft end without shaft shoulder
编码器方案 / Encoder solution:	MAG	MAG
安装 / Mounting:	夹紧元件	Clamping element
特点 / Special features:	现有设备的改造	Modernization of an existing installation



MAG 包含光纤连接的扫描头
MAG incl. scanning head for fiber optic connection



在 RMG 的起升装置上安装 MAG
Installation of the MAG at the crane hoist of a RMG crane

应用 / Application	盐矿泵电机	Pump motor in salt mine
安装情况 / Installation situation:	无自由轴端，无轴肩	No free shaft end without shaft shoulder
编码器方案 / Encoder solution:	MAG-G 带分瓣脉冲轮	MAG-G with split pulse wheel
安装 / Mounting:	安装在定心环上	Mounted at centering ring
特点 / Special features:	改造，空间狭窄，由熟练的 Hübner 人员安装，高速	Retrofit, narrow space, installed by skilled Hübner personnel, high speed



由于空间狭窄，需要改造
Demanding retrofit due to narrow spaces



用分瓣脉冲轮实现不拆卸安装
Realization with split pulse wheel without dismantling of installation

应用实例 / Application examples

应用 / Application	热轧辊道电机	Roller table motor in hot rolling mill
安装情况 / Installation situation:	有自由轴端，无轴肩	Free shaft end without shaft shoulder
编码器方案 / Encoder solution:	MAG	MAG
安装 / Mounting:	夹紧在锥形轴上	Clamped onto tapered shaft
特点 / Special features:	定制锥形轴上的装配	Customized for assembly on tapered shaft



辊道电机面对高冲击和振动载荷
Roller table motors are exposed to high shock and vibration loads

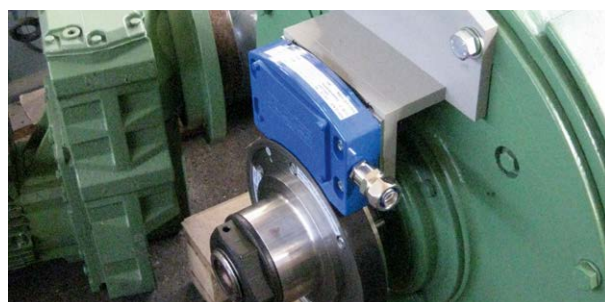

与标准编码器相比，无轴承 MAG 系统具有更长的使用寿命
The bearing-free MAG system has an extended lifetime compared to standard encoders

应用 / Application	试验台电机	Test stand motor
安装情况 / Installation situation:	有自由轴端，有轴肩	Free shaft end with shaft shoulder
编码器方案 / Encoder solution:	MAG	MAG
安装 / Mounting:	紧固到轴肩	Screwed at shaft shoulder
特点 / Special features:	改造，电机外壳安装，超薄设计	Modernization, installation in motor housing, extra-slim design

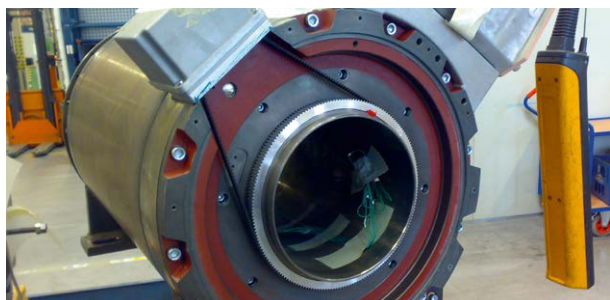

改造前：带齿带的外置编码器；齿带振动信号出现问题
Before: external encoder with tooth belt; signal problems through tooth belt vibration



改造后：通过电机外壳直接安装定制的 MAG 系统获得精确信号
After: Precise signals through direct mounting of the customized MAG system in the motor housing

安装情况及附件解决方案 Installation situations and attachment solutions

有自由轴端，有轴肩/Free shaft end with shaft shoulder

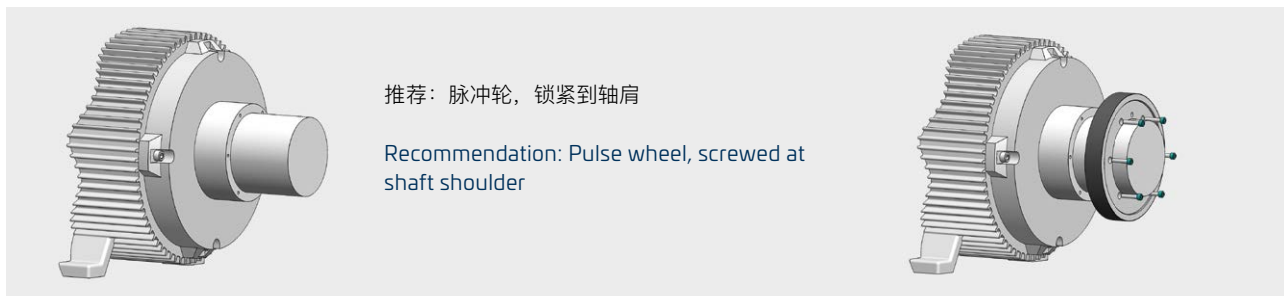

有自由轴端，无轴肩/Free shaft end without shaft shoulder

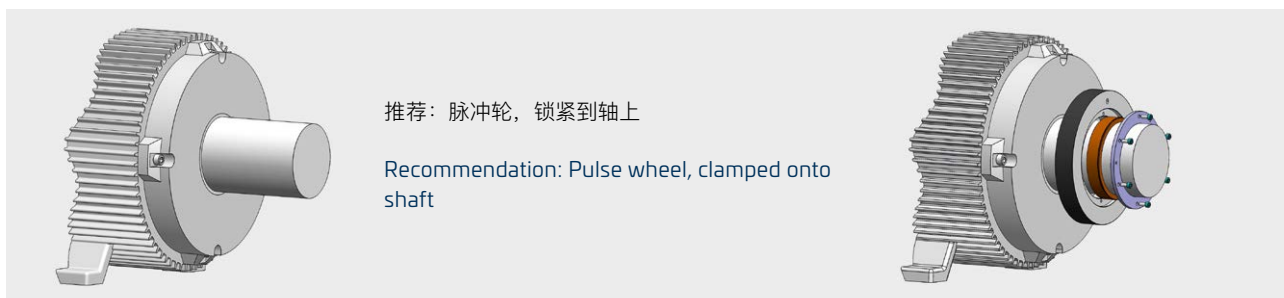

无自由轴端，有轴肩/No free shaft end with shaft shoulder

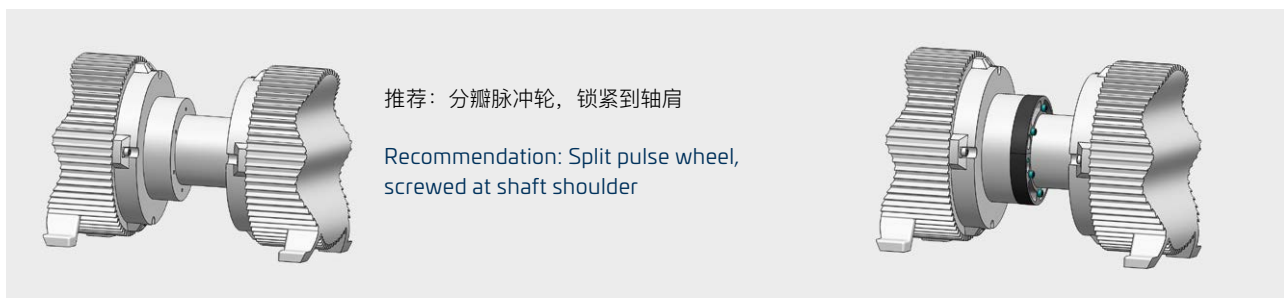

无自由轴端，无轴肩/No free shaft end without shaft shoulder



选项 Options

选项 FOC: 信号传输通过光缆

- 无干扰信号传输
- 长距离传输, 可达 1000m
- 全部通道仅需一根光缆
- 解码器带有2组输出
- 可选项: 光缆破损指示

运行模式

编码器信号 0°, 90°, 标志脉冲以及错误输出被编码和传送通过1根光缆。信号在电控柜内被解码并且带有反向信号。更多的信息详见光纤样本

Option FOC: Signal transmission via fiber optic cable

- Interference-free signal transmission
- For long transmission paths up to 1000 m
- One single fiber optic cable for all channels
- Decoder with 2 output blocks
- Optionally available with FOC cable break monitoring

Mode of operation

The encoder signals 0°, 90°, reference pulse and error output are coded and transmitted via only one fiber optic cable. They are decoded in the switchboard and provided with inverted signals. For further information see fiber optics catalog.

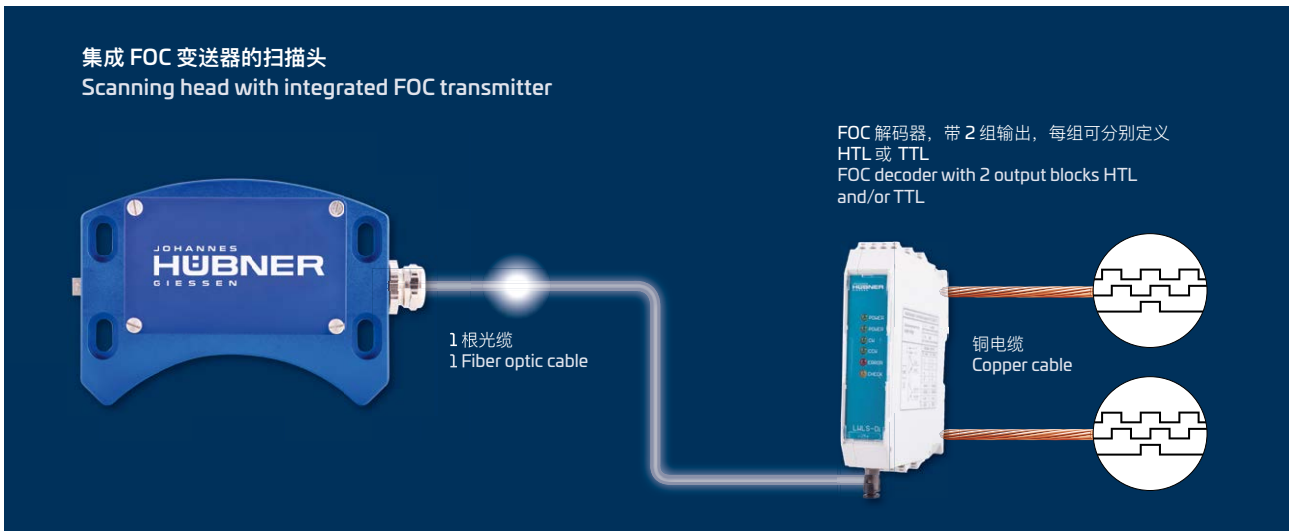

选项 S: 电子超速开关

- | | |
|------------|------------------------|
| • 单独供电: | 不需要 |
| • 超速点个数: | 1 (工厂设定) |
| • 切断速度范围: | 0,63 到 5600 rpm |
| • 切断电压/电流: | 2 - 30 VDC / 最大 300 mA |
| • 切断迟滞: | 10 % |

操作模式

电子超速开关的切断数值由工厂设定, 范围在 0.63 到 5600 rpm 之间。(订货时需指定)



Option S: Electronic overspeed switch

- | | |
|-------------------------------|--------------------------|
| • Separate power supply: | Not required |
| • Number of operating speeds: | 1 (set at factory) |
| • Switching speed range: | 0.63 to 5600 rpm |
| • Switching voltage/current: | 2 - 30 VDC / max. 300 mA |
| • Switching hysteresis: | 10 % |

Mode of operation



The electronic overspeed switch shifts at an individual defined switching speed, which is between 0.63 and 5600 rpm and is set at factory.
(Necessary information for order.)

技术参数/Technical data

机械参数/Mechanical data	
空心轴* Hollow shafts*:	可达 \varnothing 1500 mm up to \varnothing 1500 mm
机械安装 Mechanical installation:	轴心定位 Centering adapted to customer shaft
保护等级 Degree of protection:	IP66 到 IP68 (EN 60529) 取决于连接形式 IP66 to IP68 (EN 60529) acc. to connection type
轴向偏差 (扫描头与脉冲轮的偏移量) Axial tolerance (offset pulse wheel/scanning head):	± 3 mm (标准 MAG 和 MAGA); ± 8 mm (可选 MAG 和 MAGA) ± 3 mm (standard MAG and MAGA); ± 8 mm (optional MAG and MAGA)
径向偏差 (扫描头与脉冲轮的间隙) Radial tolerance (air gap pulse wheel/scanning head):	0,1 – 2,0 mm (MAG 增量); 0,1 – 1,0 mm (MAGA 绝对值) 0.1 – 2.0 mm (MAG incremental); 0.1 – 1.0 mm (MAGA absolute)
认证 Certification:	UL/CSA, ATEX/IECEX  

* 根据要求提供其他尺寸/*Further dimensions on request

MAG 增量 / MAG incremental

电气参数/Electrical data	 INCREMENTAL ENCODER  OVERSPEED SWITCH
供电电压/Supply voltage	12 – 30 VDC
空载电流 (在 24 V) No-load current (at 24 V)	约 / ca. 50 mA
最大频率/Max. frequency	200 kHz
温度范围/Temperature range	-40 °C ... +85 °C
脉冲率/Pulse rate	可达/up to 100.000 ppr
输出信号/Output signals	0° 信号 (A)和反向信号 (\bar{A})/0° signal (A) and inverted signal (\bar{A}) 90° 信号 (B)和反向信号 (\bar{B})/90° signal (B) and inverted signal (\bar{B}) 标志脉冲 (N)和反向信号 (\bar{N})/Reference pulse (N) and inverted signal (\bar{N}) 错误输出 (ERR) 和反向信号 (\bar{ERR})/Error output (ERR) and inverted signal (\bar{ERR}) 选项: 电子超速开关 EGS/ Optional: Electronic overspeed switch EGS
信号幅值/Signal amplitudes	HTL (约等于供电电压)/HTL (corresponds approx. to power supply); TTL (RS-422)/TTL (to RS-422)
电气接线/Electrical connection	端子箱/Terminal box 直出电缆/Fix connected cable EMC 电缆填料函/EMC cable gland Burndy 插头/Burndy plug M12 或 M23 插头/M12 or M23 plug 光纤连接/Fiber optic connection

技术参数/Technical data

MAGA 绝对值/MAGA absolute

电气参数/Electrical data		
接口*/Interface*	SSI	EtherCAT
数据格式/Data format	格雷码, 二进制/Gray, binary	二进制/Binary
输出数据/Output data	位置/Position	位置, 速度, 采样时间/Position, speed, sample time
运行电压/Operating voltage	12 – 30 VDC	12 – 30 VDC
空载电流 (在 24 V) No-load current (at 24 V)	100 mA	150 mA
温度范围/Temperature range	-40°C ... +85°C	-40°C ... +85°C
分辨率/Resolution	12 到/up to 16 Bit	最大/max. 16 Bit
设定零点位置/Set zero position	硬件输入/Hardware input	通过总线接口可编程 Programmable via bus interface
反向计数 Reverse count direction	硬件输入/Hardware input	通过总线接口可编程 Programmable via bus interface
在同一扫描头内增加增量信号/Additional incremental signals in same scanning head	是/yes	-
信号通道 A, B/Signal channels A, B	每圈可达 100,000 脉冲 up to 100,000 pulses per revolution	-
标志脉冲/Reference pulse	是, 带附加磁道 yes, with additional magnetic track	-
独立扫描头提供附加增量信号/Additional incremental signals in separate scanning head	是/yes	是/yes
信号通道 A, B/Signal channels A, B	每圈可达 100,000 脉冲 up to 100,000 pulses per revolution	每圈可达 100,000 脉冲 up to 100,000 pulses per revolution
标志脉冲/Reference pulse	是, 带附加磁道 yes, with additional magnetic track	是, 带附加磁道 yes, with additional magnetic track
电气连接 Electrical connection	工业标准 接头 (Burndy, M23, 其它可指定) 或者直出电缆/Industrial standard connector (Burndy, M23, others on request) or fix connected cable	至接口标准 To interface standard

*更多接口可指定/*Further interfaces on request

Johannes Hübner

Fabrik elektrischer Maschinen GmbH
Siemensstrasse 7
35394 Giessen
Germany
Tel./Phone: +49 641 7969-0
Fax: +49 641 73645
E-mail: info@huebner-giessen.com
www.huebner-giessen.com

中国代理:

鞍山维盛自动化科技有限公司
地址: 辽宁省鞍山市高新区千山中路 153 号
鞍山软件园二期三楼
总机: 0412-5223868
手机: 13941248798/13504120338
传真: 0412-5214675
E-mail: info@aswisdom.com
网址: www.aswisdom.com



世界范围合作伙伴 | Partner worldwide

