



Operating and Assembly Instructions

Universal-Encoder-System

U-ONE[®]-Compact UOC40

and

Electronic Position Switch ERC40

Read the operating and assembly instructions prior to assembly, starting installation and handling!
Keep for future reference!



UOC 40 / ERC 40

Operating and Assembly Instructions

Trademark

Brand names and product names are trademarks or registered trademarks of their respective owner.

Protected trademarks bearing a TM or [®] symbol are not always depicted as such in the manual.

However, the statutory rights of the respective owners remain unaffected.

Manufacturer / publisher

Johannes Hübner

Fabrik elektrischer Maschinen GmbH

Siemensstraße 7

35394 Giessen

Germany

Phone: +49 641 7969 0

Fax: +49 641 73645

Internet: www.huebner-giessen.com

E-Mail: info@huebner-giessen.com

The manual has been drawn up with the utmost care and attention. Nevertheless, we cannot exclude the possibility of errors in form and content. It is strictly forbidden to reproduce this publication or parts of this publication in any form or by any means without the prior written permission of

Johannes Hübner Fabrik elektrischer Maschinen GmbH.

Johannes Hübner Fabrik elektrischer Maschinen GmbH is listed by Underwriters Laboratories.

UL certificates can be requested from us.

An overview of our UL devices can be found at the following link:

<https://iq.ulprospector.com/info>

UL File Number: E351535

“Universal encoder system, Series UOC40, followed by -I, -F, or -G, may be followed by -A, -AA, -D, -DD, -O, or a combination of these”,

“Universal encoder system, Series ERC40, followed by -I, followed by -3, -6, -9, -12, or -15”,

Subject to errors and changes due to technical improvements.

Copyright © Johannes Hübner Fabrik elektrischer Maschinen GmbH.

All rights reserved.

Table of contents

1	General	5
1.1	Information about the Operating and Assembly Instructions	5
1.2	Scope of delivery	5
1.3	Explanation of symbols	5
1.4	Warranty and liability	6
1.5	Organizational measures	6
1.6	Copyright	6
1.7	Guarantee terms.....	7
1.8	Customer service.....	7
2	Basic safety instructions	7
2.1	Responsibility of the owner	7
2.2	Personnel selection and qualification; basic obligations	7
2.3	Intended use.....	8
2.4	Non-intended use	8
2.5	Safety information.....	9
3	Assembly	10
3.1	Safety instructions	10
3.2	Technical notes	11
3.3	Mounting B5 type (flange).....	13
3.4	Mounting of construction type B35 (flange and foot)	14
3.5	Dismantling.....	15
3.5.1	Dismantling the encoder.....	15
3.5.2	Replacing the UOC 40 / ERC 40	15
4	Installation	16
4.1	Basic rules	16
4.2	Electrical connection.....	16
5	Technical Data	17
5.1	Type plate.....	17
5.2	Type key UOC 40	18
5.3	Type key ERC 40.....	18
5.4	Mechanical data	19
6	Design and function	20
6.1	Basic unit.....	20
6.1.1	Electrical Data	21
6.1.2	Operating statuses and indicators	22
6.1.3	Error- and status output.....	22
6.1.4	Reset input.....	22
6.1.5	Preset input.....	23
6.1.6	Incremental output (UOC 40 only)	23
6.1.7	Electrical data incremental output.....	23
6.1.8	Current output 4–20 mA.....	24
6.1.9	Current value of the difference between two position values	24

UOC 40 / ERC 40

Operating and Assembly Instructions

6.2	Position switch module with safety relays	26
6.2.1	Electrical data position switch.....	26
6.3	Position switch module with solid state relays.....	27
6.3.1	Electrical data speed switch	27
6.4	Speed switch module with safety relay (UOC 40 only)	28
6.4.1	Electrical data speed switch:	28
6.4.2	Switching accuracy	28
6.5	Error switch.....	29
6.6	PROFIBUS module (UOC 40 only)	29
6.6.1	Profibus profile for the encoder	30
6.6.2	Electrical data PROFIBUS.....	31
6.6.3	LED display for error and status messages	32
7	Inspections	33
7.1	Safety instructions	33
7.2	Maintenance information.....	33
7.3	Inspection schedule	33
7.4	Fault table.....	34
7.5	Checklist.....	35
8	Transport, packaging and storage	36
8.1	Safety information concerning transport.....	36
8.2	Goods inward inspection.....	36
8.3	Packaging (disposal)	36
8.4	Storing packages (devices).....	36
8.5	Returning devices (repairs/goodwill/warranty).....	37
8.6	Disposal.....	37
9	Accessories	37
9.1	Spare parts	37
9.2	Coupling	38
10	Documents.....	39
10.1	Dimension drawing	39
10.2	Connection Diagrams	40

1 General

1.1 Information about the Operating and Assembly Instructions

These operating and assembly instructions provide important instructions for working with the universal encoder system U-ONE® Compact UOC 40 and the ERC 40 electronic position switch. They must be carefully read prior to starting all tasks, and the instructions contained herein must be followed.

The universal encoder system U-ONE® Compact UOC 40 and the ERC 40 electronic position switch is referred as UOC 40 / ERC 40 in the following documentation.

In addition, applicable local regulations for the prevention of industrial accidents and general safety regulations must be complied with.

1.2 Scope of delivery

The scope of supply of the UOC 40 / ERC 40 includes the fastening screws, the operating and assembly instructions, the configuration instructions for further function modules, the Software & Support CD as well as a USB programming cable.

1.3 Explanation of symbols

Warnings are indicated by symbols in these operating and assembly instructions. The warnings are introduced by signal words that express the scope of the hazard. To prevent accidents, personal injuries and material damage it is imperative to observe the information provided and proceed with due care and attention at all times.



WARNING!

Indicates a possibly dangerous situation that can result in death or serious injury if it is not avoided.



CAUTION!

Indicates a possibly dangerous situation that can result in minor injury if it is not avoided.



CAUTION!

Indicates a possibly dangerous situation that can result in material damage if it is not avoided.



NOTES!

Indicates useful tips and recommendations as well as information for efficient and trouble-free operation.



NOTES!

Do not use a hammer or similar tool when installing the device due to the risk of damage occurring to the bearings or coupling.



DANGER!

Life-threatening danger due to electric shock!

Indicates a life-threatening situation due to electric shock. If the safety instructions are not complied with there is danger of serious injury or death. The work that must be executed should only be performed by a qualified electrician.

UOC 40 / ERC 40

Operating and Assembly Instructions

1.4 Warranty and liability

In principle the "General Terms and Conditions" of Johannes Hübner Fabrik elektrischer Maschinen GmbH apply. These are available to the operator with the Order Confirmation or when the contract is concluded at the latest. Warranty and liability claims in the case of personal injury or damage to property are excluded, as well as the operating license expires if they result from one or more of the following causes:

- Non-observance of the operating and assembly instructions.
- Non-intended use of the UOC 40 / ERC 40.
- Improper assembly, installation, start-up and programming of the UOC 40 / ERC 40.
- Work carried out incorrectly on the UOC 40 / ERC 40.
- Operation of the USC 42 with technical defects.
- Mechanical or electrical modifications to the UOC 40 / ERC 40 undertaken autonomously.
- Repairs carried out autonomously.
- Third party interference and Acts of God.
- Deployment of non-qualified personnel.
- Opening of the UOC 40 / ERC 40 or modifications (with the exception of terminal boxes).

1.5 Organizational measures

- The operating and assembly instructions must always be kept ready-to-hand at the place of use of the UOC 40 / ERC 40.
- In addition to the operating and assembly instructions, generally valid legal and other binding regulations on accident prevention and environmental protection must be observed and communicated.
- The respective applicable national, local and system-specific provisions and requirements must be observed and communicated.
- The operator is obliged to inform personnel on special operating features and requirements.
- Prior to commencing work, personnel working with the UOC 40 / ERC 40 must have read and understood the chapter 2.
- The nameplate and any prohibition or instruction symbols applied on the UOC 40 / ERC 40 must always be maintained in a legible state.
- Do not undertake any mechanical or electrical modifications to the UOC 40 / ERC 40, except for those expressly described in this operating and assembly instructions.
- Repairs may only be undertaken by the manufacturer or a center or person authorized by the manufacturer.

1.6 Copyright

	<p>NOTES!</p> <p>Content information, text, drawings, graphics, and other representations are protected by copyright and are subject to commercial property rights. It is strictly forbidden to make copies of any kind or by any means for any purpose other than in conjunction with using the UOC 40 / ERC 40 without the prior written agreement of the manufacturer. Any copyright infringements will be prosecuted.</p>
---	--

1.7 Guarantee terms

The guarantee terms are provided in the manufacturer's terms and conditions.

1.8 Customer service

For technical information personnel is available that can be reached per telephone, fax or email. See manufacturer's address on page 2.

2 Basic safety instructions

	<p>DANGER!</p> <p>This section provides an overview of all the important safety aspects that ensure protection of personnel, as well as safe and trouble-free UOC 40 / ERC 40 operation.</p> <p>If these safety instructions are not complied with significant hazard can occur.</p>
---	---

2.1 Responsibility of the owner

The UOC 40 / ERC 40 is used in commercial applications. Consequently the owner of the UOC 40 / ERC 40 is subject to the legal occupational safety obligations, and subject to the safety, accident prevention, and environmental protection regulations that are applicable for the UOC 40 / ERC 40 area of implementation.

2.2 Personnel selection and qualification; basic obligations

- Qualified personnel must only carry out all work on the UOC 40 / ERC 40. Qualified personnel includes persons, who, through their training, experience and instruction, as well as their knowledge of the relevant standards, provisions, accident prevention regulations and operating conditions, have been authorized by the persons responsible for the system to carry out the required work and are able to recognize and avoid potential hazards. They are capable of identifying and avoiding potential hazards.
- The definition of "qualified personnel" also includes an understanding of the standards VDE 0105-100 and IEC 364 (source: e.g. Beuth Verlag GmbH, VDE-Verlag GmbH).
- The responsibility for assembly, installation, commissioning and operation must be clearly defined. The obligation exists to provide supervision for trainee personnel.

UOC 40 / ERC 40

Operating and Assembly Instructions

2.3 Intended use

Depending on the device configuration the UOC 40 / ERC 40 can be used,

- to detect angular movements via Profibus (only UOC 40)
- for position-dependent switching of floating relay contacts
- for speed-dependent switching of floating relay contacts (only UOC 40)
- for error-dependent switching of floating relay contacts

The system manufacturer must check that the characteristics of the UOC 40 / ERC 40 satisfy his application-specific safety requirements. The responsibility or decision regarding the use of the UOC 40 / ERC 40 lies with the system manufacturer. The UOC 40 / ERC 40 is designed for unattended continuous operation.

Intended use also includes:

- observing all instructions in this operating and assembly instructions
- observing the nameplate and any prohibition or instruction symbols on the UOC 40 / ERC 40
- observing the operating instructions from the machine/system manufacturer
- operating the UOC 40 / ERC 40 within the limit values specified in the technical data
- safe mounting (form-closed) of the UOC 40 / ERC 40 to the driving axis
- Omission of a non-intended use

For UL and CSA:

For the use in NFPA 79 applications only.

2.4 Non-intended use

	<p>WARNING!</p> <p>Danger of death, physical injury and damage to property in case of non-intended use of the UOC 40 / ERC 40!</p> <p>The following areas of use are especially forbidden:</p> <ul style="list-style-type: none">• in environments where there is an explosive atmosphere.• use in environments with radioactive radiation.• use on ships.• for medical purposes.• fastening transport or lifting tackle to the UOC 40 / ERC 40, for example a crane hook to lift a motor.• fastening packaging components to the UOC 40 / ERC 40, for example ratchet straps, tarpaulins etc..• using the UOC 40 / ERC 40 as a step, for example by people to climb onto a motor.
---	---

2.5 Safety information

	<p>WARNING! NOTICE! NOTES!</p> <p>Destruction, damage and malfunction of the UOC 40 / ERC 40!</p> <ul style="list-style-type: none"> • Only carry out wiring work or opening and closing of electrical connections with the system de-energized. • Falling below or exceeding the permissible operating temperature limit values must be prevented through an appropriate heating/cooling measure at the place of installation. • The power supply unit used must not exceed a voltage of 36 VDC even during a fault condition or corresponding voltage limiting measures must be employed, for example installing a surge suppressor. • Potential hazards resulting from interactions with other systems and equipment which are or will be installed in the vicinity must be checked. The user is responsible for taking appropriate measures. • The power supply must be protected with a fuse suitable for the supply lead cross-section. • Cables used must be suitable for the temperature range. • Make sure that the installation environment is protected from aggressive media (acids etc.). • Avoid shocks (e.g. hammer blows) to the shaft during installation. • Using the UOC 40 / ERC 40 as a step etc. is non intended. • Opening the UOC 40 / ERC 40 is forbidden (with the exception of terminal boxes). • Make sure that the access to the address switches and terminal boxes is locked securely after installation or settings. • The type plate specifies the technical characteristics of the UOC 40 / ERC 40. If the type plate is no longer legible or if the type plate is completely missing, the UOC 40 / ERC 40 must not be operated. Contact Hübner Service (see page 2)! • The user must ensure that the system limits are not exceeded even in the switched-off state. • The relay contacts must be protected against over current by a backup fuse (2A). • The USB interface is only to be used for parameterization and commissioning and is not designed for continuous operation in a "rough" environment. • Setting the preset "on the fly" is only permissible if a risk analysis has shown that the application is suitable for this purpose.
--	---

	<p>NOTES!</p> <p><i>Disposal</i></p> <p>If disposal has to be undertaken after the lifespan of the UOC 40 / ERC 40, the respective applicable country-specific regulations are to be observed.</p>
---	--

UOC 40 / ERC 40

Operating and Assembly Instructions

3 Assembly

3.1 Safety instructions



WARNING!

- At assembly, dismantling and other work to the UOC 40 / ERC 40 the basic safety instructions to chapter 2 must be observed.
- The assembly and the dismantling of the UOC 40 / ERC 40 must only be carried out by qualified personnel!



DANGER! NOTICE!

- The system manufacturer must implement suitable design measures, so that the drive of the UOC 40 / ERC 40 is ensured at all times through the shaft and mounting (see chapter 3.2) of the UOC 40 / ERC 40.
- In general, the requirements and acceptance conditions for the complete system must be taken into account for mounting.
- For mounting the UOC 40 / ERC 40, we recommend our clearance-free, torsionally rigid HK5 coupling (see chapter 9.2 coupling).

As the installation situation is application-dependent, the following notes are not exhaustive.

- All fastening screws must be secured against unintentional loosening.
- In case of applications with low operating temperatures, increased values for the start-up torque result.
- A suitable coupling with positive connection must be used for the application.
- The coupling manufacturer's information and installation requirements must be observed.

In particular, you must ensure that:

- the coupling is suitable for the possible axial and radial offset, as well as the permissible speed range.
- the coupling is not radially and axially loaded,
- the clamping screws are tightened with the torque defined by the coupling manufacturer and are secured against unintentional loosening, so that the coupling cannot slip on the drive shaft or onto the UOC 40 / ERC 40 shaft.

3.2 Technical notes

	<p>NOTES!</p> <p>Do not use a hammer or similar tool during installing, disassembly or other work on the UOC 40 / ERC 40 due to the risk of damage occurring to the bearings or coupling.</p>
---	--

Housing surface temperature

The housing surface temperature must be within the permissible range (see chapter 5.4).

Degree of protection

The UOC 40 / ERC 40 complies with the specified degree of protection (see chapter 5.4) only with screwed-on mating connectors or blind plugs and closed terminal boxes!

To fulfill degree of protection requirements the diameter of the connection cable must correspond to that of the cable gland!

	Connection-thread	Sealing area max./min. Ø mm	Sealing area without inlet max./min. Ø mm	Sealing area with inlet max./min. Ø mm
Basis X1	M20x1,5	13,0 – 9,0	-	-
	M25x1,5	20,0 – 11,0	20,0 – 16,0	16,0 – 11,0
Extensions X2; X3; X4; X5	M20x1,5	14,0 – 5,0	14,0 – 9,0	9,0 – 5,0
	M25x1,5	20,0 – 11,0	20,0 – 16,0	16,0 – 11,0

Deep groove ball bearings

The UOC 40 / ERC 40 are fitted with maintenance-free, greased "for-life" deep groove bearings. Bearings must be changed by the manufacturer only.

Screw retention

All fastening screws must be secured against unintentional loosening. We recommend using Loctite® 243 thread locker (medium strength).

Required tools

Spanners: 10 mm, 13 mm, 22 mm, 24 mm 30 mm

Allen key: 5 mm, 6 mm

Flat-blade screwdriver

Assembly grease

Loctite® 243 (medium strength thread locker)

UOC 40 / ERC 40

Operating and Assembly Instructions

Fastening screws

To ensure the encoder is professionally mounted the following conditions must be satisfied:

Construction type	B5 flange mounting	B3 foot mounting	
Screws	ISO 4017 M6	ISO 4017 M8	
Washers	ISO 7089 A6	DIN 6340 A8	
Number of screws	Min. 6 pcs.	4 pcs.	
Property class ISO 898-1	8.8	12.9	
Length of screws	20 mm	30 mm	35 mm
Tensile strength of internal thread	Min. 280 N/mm ²	Min. 460 N/mm ²	Min. 330 N/mm ²
Tightening torque	6 Nm	27 Nm	
Centering	85 _{±6}	-	



NOTES!

Suitable measures must be taken if the minimum tensile strength of the internal thread of the customer interface does not meet requirements (e.g. fit a threaded insert).

Mounting preparations

1. Ensure all accessories are available.
2. Preparing the place of attachment: Clean the drive shaft, centering, bolting surfaces and fastening threads; check for damage. Repair any damage!

Personnel

Mounting and commissioning must only be carried out by qualified personnel.



NOTES!

Observe the safety instructions contained in **chapter 2** when mounting or commissioning.

3.3 Mounting B5 type (flange)



NOTES!

For a mounting example please refer to dimension drawing (chapter 10).

- The installation described below is offered as an example only and may vary according to the coupling and flange type. It is essential to observe the specific instructions provided by the manufacturer of the coupling.
- You must be able to mount the coupling without force. Ream out the bores of used couplings, if necessary.
- If possible, fit the intermediate flange (4) in a manner that ensures the screwed sealing plug (16) points downwards!
- If possible, fit the device in a manner that ensures the cable gland points downwards Exchange the position of the cable gland (19) and the blanking plug (16), if necessary.
- To carry out step 9, it may be necessary to turn the drive shaft (1) to the correct position.

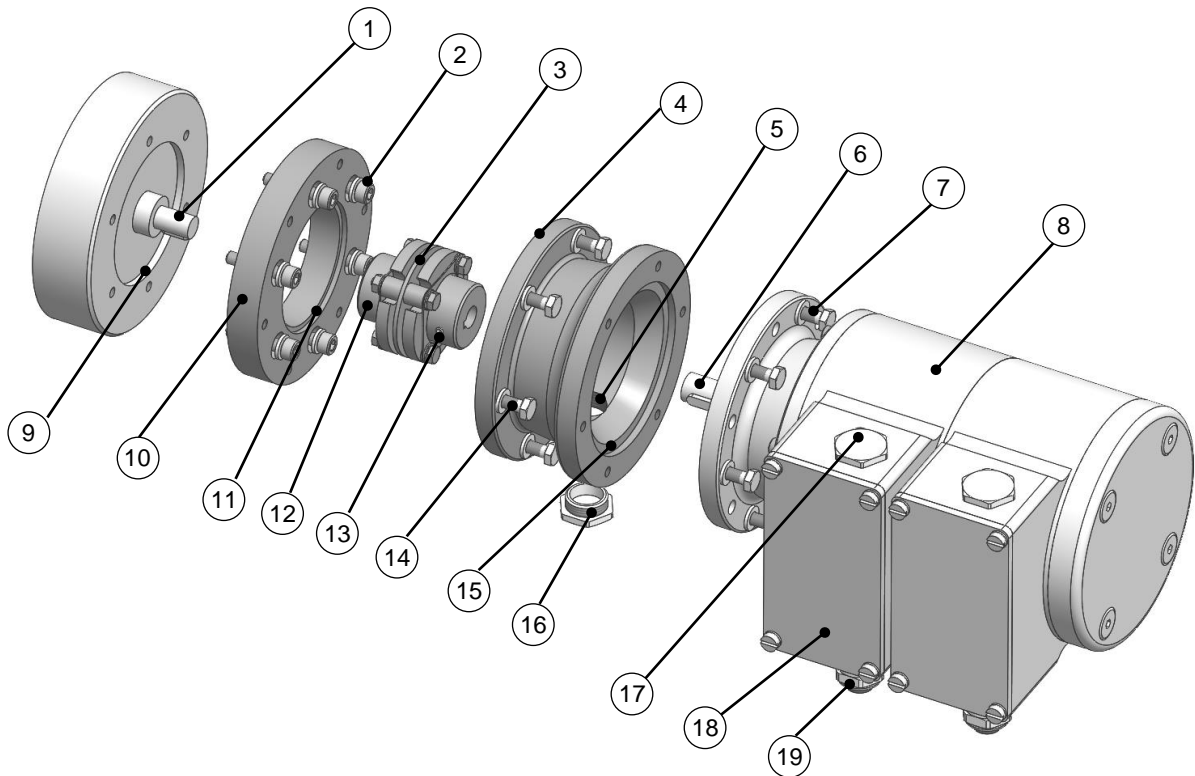

Fig. 3-1 Example construction type B5

1. Grease the drive shaft lightly (1).
2. Fit coupling (3) onto drive shaft (1).
3. Secure the coupling hub on the drive shaft (1) using a grub screw or a screw (12) (depending on the coupling type).
4. Fasten the intermediate disc (10) on the drive side by using of the fastening screws and washers (2).
5. Fasten the intermediate flange (4) to the intermediate disc (10) by using the fastening screws(14) and washers (14).

UOC 40 / ERC 40

Operating and Assembly Instructions

6. Grease the UOC 40 / ERC 40 shaft lightly (6).
7. Fit the UOC 40 / ERC 40 (8) into both the centering (15) and coupling hub (13) at the same time.
8. Secure the UOC 40 / ERC 40 with min. 6 screws (7) and washers evenly distributed around the circumference of the flange (4).
9. Remove the sealing plug (16) from the access bore (5) to the coupling.
10. Secure the coupling hub on the shaft with a grub screw or screw (13) (depending on the coupling type).
11. Close access bore in the intermediate flange (4) for coupling with the sealing plug (16).

3.4 Mounting of construction type B35 (flange and foot)

	<p>NOTES!</p> <ul style="list-style-type: none">• B35 type encoders can be attached by means of a flange (B5, please refer to chapter 3.3) or foot (B35):• For a mounting example please refer to dimension drawing (chapter 10).• The assembly procedure described below is offered as an example only and may vary according to the type of coupling. It is essential to observe the specific instructions provided by the manufacturer of the coupling.• You must be able to mount the coupling (3) without force! Ream the bores of used couplings, if necessary!• Angle misalignment and parallel displacement between the (drive) shaft (1) and the UOC 40 / ERC 40 shaft are mounting errors and should be kept as small as possible. <p>Mounting errors:</p> <ul style="list-style-type: none">- Cause radial forces to act on the UOC 40 / ERC 40 shaft.- Reduce the service life of the bearings and the coupling.- Degrade the quality of the signals (harmonic content).
---	--

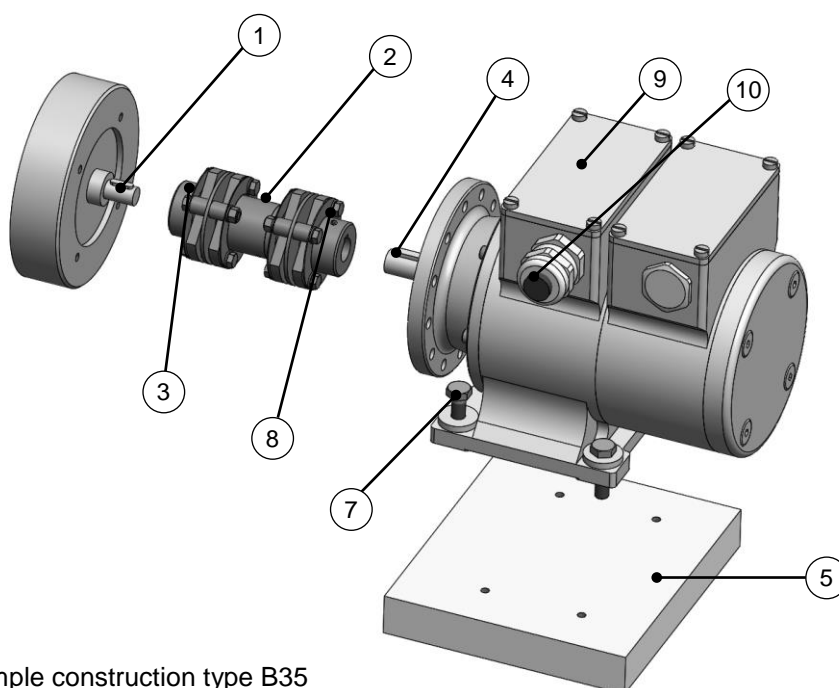

Fig. 3-2 Example construction type B35

1. Grease the drive shaft lightly (1).
2. Secure the coupling hub on the drive shaft (1) with a grub screw or cheese head screw (3) (depending on the coupling type).
3. Grease the UOC 40 / ERC 40 shaft lightly (4).
4. Align the UOC 40 / ERC 40 shaft (4) to the drive shaft (1) and insert into the coupling hub.
5. Fasten UOC 40 / ERC 40 foot with 4 screws-M8 and matching washers (7).
6. Secure the coupling hub on the shaft with a grub screw or with a screw (8) (depending on the coupling type).

3.5 Dismantling

Personnel

Dismantling must be carried out by qualified personnel only.



WARNING!

Observe the safety instructions contained in chapter 2 when dismantling the UOC 40 / ERC 40.



NOTES!

Do not use a hammer or similar tool when dismantling the UOC 40 / ERC 40 due to the risk of damage occurring to the bearings or coupling.

3.5.1 Dismantling the encoder

Remove all electrical connection cables of the UOC 40 / ERC 40 before dismantling.

To dismantle the UOC 40 / ERC 40 follow the instructions given in chapter 3.3 or rather 3.4 in the reverse order.

3.5.2 Replacing the UOC 40 / ERC 40

The following points must be noted when replacing the UOC 40 / ERC 40:

- The new UOC 40 / ERC 40 must have the same order number (ID) as the UOC 40 / ERC 40 being replaced.
- The new UOC 40 / ERC 40 must be installed in accordance with the specifications and requirements in chapter 4.2.
- The new UOC 40 / ERC 40 must be connected in accordance with the specifications in chapter 4.2.
- The configuration of the UOC 40 / ERC 40 to be exchanged can be transferred to the new UOC 40 / ERC 40 (see configuration manual).
- When recommissioning the replaced UOC 40 / ERC 40, correct functioning must be ensured first of all by means of a protected test run.

in addition, with UOC 40 with PROFIBUS

- With a new UOC 40 ensure that the PROFIBUS address and bus termination set via hardware switches match that of the UOC 40 to be installed.

4 Installation

4.1 Basic rules

	<p>WARNING!</p> <ul style="list-style-type: none"> • Observe SELV and PELV requirements (IEC 60364-4-41). • Equipotential bonding measures must be provided throughout the entire processing chain of the plant. • Route power and signal cables separately. • Observe the manufacturer's instructions for the installation of converters and for shielding power cables between frequency converter and motor. • Ensure adequate dimensioning of the energy supply. • The line cross-section of the voltage supply line must be designed in such a way that the max. Voltage drop is < 3V. <p>PROFIBUS</p> <ul style="list-style-type: none"> • Only use M12 connectors for connecting, which guarantee good contact between the cable shield and connector housing. The cable shield must be connected to the connector housing over a large area.
---	--

4.2 Electrical connection

	<p>NOTES for UL and CSA! Do only use copper cables.</p>
---	--

1. Open the terminal box cover (9) (Fig. 3-2).

	<p>CAUTION! Do not allow moisture to enter the terminal box when the terminal cover is open.</p>
---	---

2. Remove the cap of the cable gland (10) (Fig. 3-2).
3. Feed the cable into the terminal box trough the cable gland.

	<p>NOTES! (only ECU C) The signal cable shielding can be connected directly to the housing via the EMC cable gland. A coil spring integrated in the cable gland ensures all-round contact is made with the bare cable shielding to ensure a good shield connection. This type of shield connection should be preferred. To achieve an effective shielding the cable shield must also be connected in the electrical cabinet. Ensure no equipotential bonding currents are able to flow across the shielding.</p>
---	---

4. Tighten the cable gland and blanking plugs using a spanner.

	<p>NOTES! Prior to delivery cable glands and blanking plugs are tightened finger tight only. To ensure that the terminal box is reliably sealed tighten all cable glands and blanking plugs before starting up for the first time.</p>
---	---

5. Use a spanner to tighten the cable gland until the cable is securely clamped and properly sealed.



NOTES!

Prevent lateral pulling forces acting on the cable and plugs so as not to impair the degree of protection of the cable gland.

- Strip cable insulation, crimp wire-end ferrules. Connect the supply voltage and signal cable (please refer to the connection diagrams, chapter 10.2).



CAUTION!

Do not apply supply voltage to the signal outputs, as this will destroy the UOC 40 / ERC 40.

- Close the terminal box cover.



NOTES!

Before closing the terminal box cover check the sealing surface is clean and that the seal is in a good condition; clean or replace damaged seals as necessary.



CAUTION!

Ensure when closing the terminal box cover that no cable becomes jammed.

5 Technical Data

5.1 Type plate

The figure below shows an example of a type plate.



The type plate and UKCA label are located on the side of the housing.

Type plate information:

- Manufacturer, address, CE-mark
- Type
- Resolution
S= Singleturn, M= Multiturn
- Serial number S/N
- Number of pulses (UOC 40 only)
- Degree of protection
- Supply voltage
- Order number (ID)
- Date of manufacturing (Y)
- Current output
- Certification information
- QR-code

Fig. 5-1: type plate (example)

UOC 40 / ERC 40

Operating and Assembly Instructions

5.2 Type key UOC 40

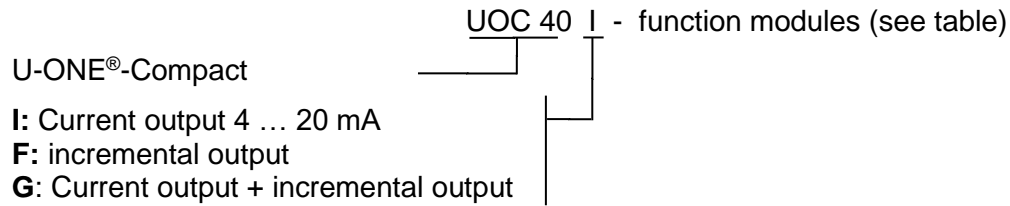

Housing modules:

The individual housing modules may contain 1 or 2 functional modules, they are separated by „-“ (eg. UOC 40I-DD-A-O) and listed in the sequence they are installed after the basic unit.

Identification	Description
UOC 40	Control Unit (ECU C) with 2 digital inputs (reset, preset) and 2 digital outputs (status, error)
I	current output 4 ... 20 mA
F	Incremental output pulse rate 1024 / 4096 (parameterizable)
A	3 speed switches (SGS C-R) (1 function module - max. switching voltage: 230 VAC / DC)
AA	6 speed switches (SGS C-R) (2 function modules - max. switching voltage: 230 VAC / DC)
D	3 position switches (ERC C-R) (1 function module - max. switching voltage: 230 VAC / DC)
DD	6 position switches (ERC C-R) (2 function modules - max. switching voltage: 230 VAC / DC)
E	3-position switch (ERC C-L) (1 functional module – solid state relays, maximum switching voltage 30 VDC)
EE	6-position switch (ERC C-L) (1 functional module – solid state relays, maximum switching voltage 30 VDC)
O	PROFIBUS

5.3 Type key ERC 40

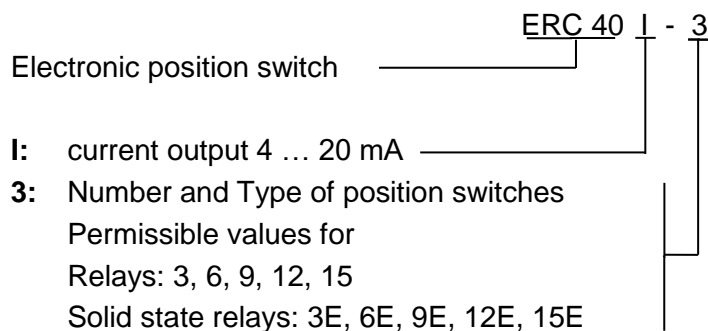

5.4 Mechanical data

Specification	Value	
Shaft load at the center of the feather key	≤ 100 N axial, ≤ 120 N radial	
Shaft end	Ø 14j6 x 30 mm	
Mech. permissible speed	max. 2800 rpm	For UL and CSA max. 1800 rpm
Working temperature	-25 °C ... + 70 °C	For UL and CSA max. 62°C
Derating	Ta = 69- (0,003286*n) in °C	
Vibration resistance	5 g (DIN EN 60068-2-6 (8,7 ... 500 Hz))	
Shock resistance	25 g (DIN EN 60068-2-27 (6 ms))	
Bearing life time L ₁₀ - speed - operating temperature	≥ 1.1 * 10 ¹¹ revolutions at 2800 rpm 70 °C	
Bearing grease life time - max. speed - max. operating temperature	20 years at 2800 rpm 65 °C	
Rotor moment of inertia	approx. 330 gcm ²	
Permissible angular acceleration	≤ 10 ⁴ rad/s ²	
Breakaway torque	approx. 3,5 Ncm	
Degree of protection acc. to DIN EN 60529	IP66 with axial shaft seal	For UL and CSA Type 1
Max. operating hight above sea level	3000 m	
Weight	Construction type B35 (basic unit + 1 module) Construction type B5 (basic unit) for each additional module	approx.5 kg approx.3.6 kg + approx 0.8 kg

Calculations pertaining to the service life were carried out using data from the manufacturer of the bearings. The stated service lifetimes are based on the modified rating life L₁₀ in accordance with ISO 281. That means, the probability that the bearings will attain or exceed the specified service lifetime is 90%.

The following factors influence the service life of the bearings

- Operating temperature
- Mechanical loads from vibration and shock
- Drive dynamics
- The influence of transport and storage (bearing grease ageing)
- Installation errors

6 Design and function

The UOC 40 / ERC 40 consists of a basic unit as well as maximum 4 housing modules in which it is possible to integrate a maximum of 6 function modules.

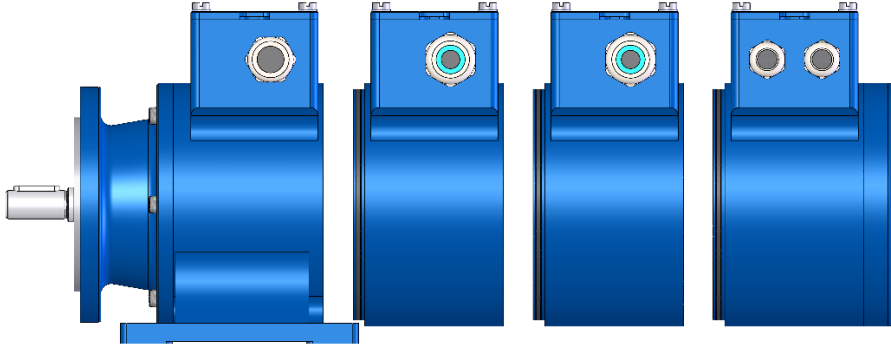

Fig. 6-1: Basic unit with 3 housing modules

It is possible to utilize max. 6 function modules, which are connected to the system bus.

The base unit consists of:

- optical Single-Turn scanning via code disk with transmitted light and magnetic Multi-Turn scanning

The UOC 40 / ERC 40 is configured using a Laptop/PC running a Windows® operating system (version XP SP3, Vista, 7, 8, 8.1, 10) in conjunction with the programming software US42Pro included in the scope of supply. The physical interface is USB.2.0 in the terminal box of the basic unit ECU C.

6.1 Basic unit

The ECU C module is the central control module of the UOC 40 / ERC 40.

The following options are available:

1. ECU C-I current output
2. ECU C-G additional incremental output to the current output (UOC 40 only)

A detailed description of the parameterization is given in the separate configuration manual.

6.1.1 Electrical Data

Specification	Value
Supply voltage	15 V...27 VDC acc. to IEC 60364-4-41, SELV/PELV For UL and CSA Class 2 supplied
Power consumption	max. 5 W plus power consumption of next modules
Connection	screw-type terminal 0,25 mm ² - 1,5 mm ²
Connecting diagram	PN164-403b (see chapter 10.2)
Programming interface	USB 2.0
Resolution Singleturn	13 Bit
Resolution Multiturn	15 Bit
Preset input (see also Chap.6.1.5)	Preset voltage Low: 0 V < U < 5 VDC Preset voltage High 8 VDC < U < 27 VDC (Ri: ca. 39 kΩ)
Reset input (see also Chap.6.1.4)	Reset voltage Low: 0 V < U < 5 VDC Reset voltage High 8 VDC < U < 27 VDC (Ri: ca. 39 kΩ)
Error output, status output (see also Chap. 6.4.1)	2-channel type with current-limited, short-circuit proof push-pull line driver Output voltage: HTL Load: max. 50 mA at 24 V



NOTICE!

The power supply unit used must not exceed a voltage of 36 VDC even during a fault condition or corresponding voltage limiting measures must be employed, for example installing a surge suppressor.

UOC 40 / ERC 40

Operating and Assembly Instructions

6.1.2 Operating statuses and indicators

Operating status	Terminal box ECU C		Output status (HTL)	Output error (HTL)	Error switch (optional)	Position / speed switch (optional)	Bus module (optional)
	Status LED (green)	Error LED (red)					
Start	Flashing 2 Hz	On	Low	Low	Open	Open	Not ready for operations
Normal	On	Off	High	High	Closed	As per program	Ready for operations
Parameter assignment	Flashing 1 Hz	Off	Change 1 Hz	High	Closed	As per program	Ready for operations *1
Test	Flashing 1 Hz	Off	Change 1 Hz	High	Closed	As per test	Ready for operations
Bootloader	Flashing 1 Hz	On	High	Low	On	On	Not ready for operations
Reset	→ Start						
Preset	1s off	Off	1s low	High	Closed	As per program	Ready for operations
Error	Off	On	Low	Low	Open	As per program (if possible)	Ready for operations

!	<p>ATTENTION! Parameterization is only possible during standstill! If a rotary movement is detected during parameterization, the UOC 40 / ERC 40 is set into the fault state.</p>
----------	---

6.1.3 Error- and status output

The basic unit of the UOC 40 / ERC 40 is equipped with an error and a status output.

Error output

An error is indicated by a low-level signal at the error output.

A reset will be initiated by interrupting the supply voltage (> 2s) or by initiating a reset at the reset input. The reset initiates a system reboot including a complete system test. If an error is determined again, the device remains in an error condition. Error logs are saved in the error memory.

Status output

The status output indicates the operating status in conjunction with the error output (see chapter 6.1.2).

6.1.4 Reset input

A reset leads to the entire UOC 40 / ERC 40 system being re-initialized.

When quiescent the input must be high level. A low level on both inputs performs a reset. The duration of the low level signal T1 can be parameterized (factory setting: 200-2000 ms).

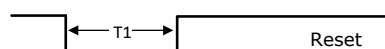

Fig. 6-2: Reset input

6.1.5 Preset input

A preset signal sets the current position to the preset position configured in the device. A low-level status output signal (approx. 1s) indicates a valid preset procedure.

When quiescent the input must be at high level. A high-low transition on both inputs initiates the preset procedure. Valid low-high transitions trigger the preset procedure. It is possible to configure the duration of the low level signal T1 (factory setting: 200 ms ... 2000 ms).

In the parameterization software, the behavior of the reset and preset inputs can be switched from low active to high-active.

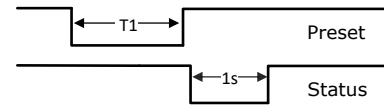
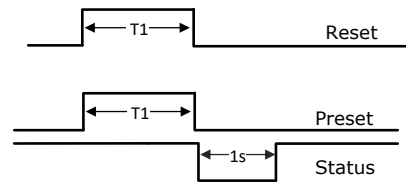

Fig. 6-3: Preset input



WARNING!

Setting the preset "on the fly" is only permissible if the results of a risk analysis determine the application is suitable for such an operation.



WARNING (UOC 40 only)!

A preset does not influence the position value of the bus module (EPF). It is only possible to alter this position value via the bus interface.

6.1.6 Incremental output (UOC 40 only)

The optional incremental output supplies 1024 or 4096 pulses / rotation. The output signals opposite are available (factory setting: 1024).

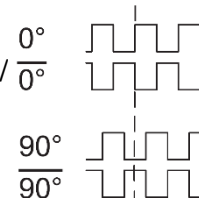

Fig. 6-4: Incremental signals

6.1.7 Electrical data incremental output

	Value
Pulse rates	4096 / 1024 (configurable)
Outputs	Current limited and short-circuit proof push-pull line driver with integrated characteristic impedance matching for 30-140 Ω lines.
Signal amplitude (HTL)	Approximately equal to the supply voltage, output saturation voltage < 0.4 V at I _L 30 mA
Output current [^]	Max. 50 mA at 24 V
Pulse duty factor	1 : 1 ± 5%
Phase shift 0°, 90°	90° ± 5%
Max. frequency	190 kHz
Connection diagram	PN164-406 (see Chap.10.2)

UOC 40 / ERC 40

Operating and Assembly Instructions

6.1.8 Current output 4–20 mA

The optional current output is parameterizable using the software US42Pro. The current value can be obtained either from the speed value or from the difference between two position values.

The load impedance (internal resistance of the measuring device) must not exceed max. 400 Ω for supply voltages < 16V and 600 Ω for supply voltages ≥ 16V. The amplitude of the unloaded output can increase at most to the amplitude of the supply voltage.

6.1.9 Current value of the difference between two position values

It is possible to select any 2 position values within the system limits. The smaller position value is assigned the current $I_{\min} = 4$ mA and larger position value $I_{\max} = 20$ mA. The selected position values must be within the resolution range of the UOC 40 / ERC 40.

If the current position is outside of the defined position range, the following current output raises:

- Variant 1: $I = 0$ mA (high impedance)
- Variant 2: Position range undershot: $I = 4$ mA
Position range overshoot: $I = 20$ mA

The behavior is configurable. Factory setting: $I = 0$ mA

Electrical data current output position:

Specification	Value
Max. position difference	32768 revolutions
Max. setting accuracy	1 / 8192 revolutions
Accuracy of the current output	0,5% FSR
Update rate	approx. 1 ms
Max. load resistance	400 Ω at supply voltage < 16V 600 Ω at supply voltage ≥ 16V
Connection diagram	PN164-404b (see chapter 10.2)

6.1.9.1 Current value of the speed value (UOC 40 only)

The max. current value ($I = 20 \text{ mA}$) can be assigned to any integer speed value (speed_{20 mA}), whereat the speed_{20mA} value must not exceed the max. permissible speed of the device.

The range is divided linearly into 4096 (12 bit) steps.

If the speed is greater than the speed of_{20 mA}-value, the following output current arises:

Variant 1: $I = 0 \text{ mA}$ (high resistance)

Variant 2: $I = 20 \text{ mA}$

The behavior is configurable. Factory setting: $I = 0 \text{ mA}$

Electrical data current output speed:

Specification	Value
Max. speed	2800 rpm
Accuracy	0,5% FSR
Update rate	approx. 2 ms
Max. load resistance	400 at supply voltage < 16V 600 at supply voltage ≥ 16V
Connection diagram	PN164-404b (see chapter.10.2)

6.2 Position switch module with safety relays

The module position switch (ERC C-R) contains switches that open or close depending on the position value. The user is able to configure a cam with a switch, in other words, a switch-on and switch-off position (red line) and the associated hysteresis switching points (blue line).

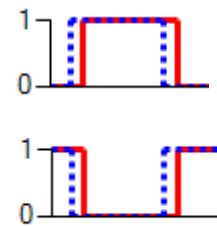

Fig. 6 - 5: Switch states SRC C-R

To set an inverted switching behavior select inverted position evaluation.

A ERC C-R type housing module contains 3 or 6 position switches. As shown in the graphic opposite each position switch is designed. The switch states are depicted when no voltage is applied.

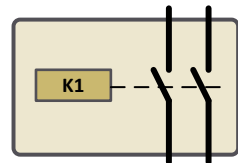



Fig. 6 - 6: Switch arrangement ERC C-R

A detailed description of the parameterization is given in the separate configuration manual.

6.2.1 Electrical data position switch

Specification	Value
Supply voltage	is supplied by ECU C
Additional module power consumption SCR C-R	3 switches max. 2,5 W / 6 switches max. 5 W
SRC C-R (positively driven relay contacts)	5 VAC ... 230 VAC 5 mA ... 500 mA 5 VDC ... 30 VDC 5 mA ... 500 mA 5 VDC ... 230 VDC 5 mA ... 180 mA
Mechanical relay life time	>10.000.000
Time between 2 switching operations required of a relay	≥ 135 ms
max. position difference	32768 revolutions
Connection	screw-type terminal 0,25 mm ² - 1,5 mm ²
Connecting diagram	PN164-420e, PN164-421e (see chapter 10.2)

Install a back-up fuse (max. 2A) to protect the relay contacts against overcurrents.

	<p>WARNING!</p> <ul style="list-style-type: none"> • Overvoltage category III: In case of a mixed population between adjacent relay outputs with SELV/PELV and mains voltage a double / reinforced insulation can be stated up to 150 V AC or 212 V DC, assuming a maximum altitude of 2000 m. An appropriate fixing of the wires is necessary to avoid cross faults between the different voltage areas. For higher voltages it must be ensured that sufficient spacing is maintained, e.g. by leaving one relay output in-between unconnected. • At a height of 2000 m - 3000 m the max. switching voltage is 150 VAC or 212 VDC.
---	--

6.3 Position switch module with solid state relays

The module position switch (ERC C-L) contains switches that open or close depending on the position value. The user is able to configure a cam with a switch, in other words, a switch-on and switch-off position (red line) and the associated hysteresis switching points (blue line).

To set an inverted switching behavior select inverted position evaluation.

A ERC C-L type housing module contains 3 or 6 position switches. Each position switch consists of 2 solid state relays that are executed in parallel, As shown in the graphic opposite each position switch is designed. The switch states are depicted when no voltage is applied.

A detailed description of the parameterization is given in the separate configuration manual.



Abb. 6-7: Switch statuses ERC C-L



Abb. 6-8: Switch arrangement ERC C-L

6.3.1 Electrical data speed switch

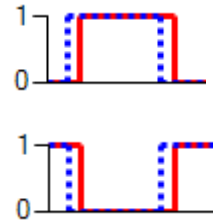
Angabe	Wert
Supply voltage	Is supplied by ECU C
Additional module power consumption SCR C-L	3 switches: max. 1,5 W / 6 switches max.: 3 W
SRC C-L (Solid state relays)	0 VDC ... 30 VDC max. 500 mA
Switching accuracy at 100 1/min	typ. +/-1° max. -1°/+2,5°
max. position difference	32768 RPM
Connection	Screw-type terminal 0,25 mm ² - 1,5 mm ²
Connecting diagram	PN164-420e / PN164-421e (Chap.10.2)

Install a back-up fuse (max. 1 A) to protect the relay contacts against overcurrents.

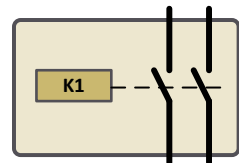
UOC 40 / ERC 40

Operating and Assembly Instructions

6.4 Speed switch module with safety relay (UOC 40 only)

The speed switch module open and close depending on the speed value. With a speed switch the user is able to configure overspeed cut-off and/or underspeed cut-off and the associated hysteresis switching points (dotted line).

By selecting the inverted speed evaluating an inverted switching behavior can be set.

A EGS C-R type housing module contains 3 or 6 speed switches. As shown in the graphic opposite each speed switch is designed. The switch statuses are depicted when no voltage is applied.

A detailed description of the parameterization is given in the separate configuration manual.

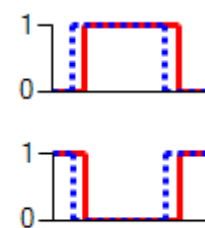

Fig. 6 - 9: Switch statuses EGS C-R

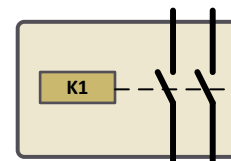

Fig. 6 - 10: Switch arrangement EGS C-R

6.4.1 Electrical data speed switch:

Specification	Value
Supply voltage	Is supplied by ECU C
Additional module power consumption EGS C-R	3 switches max. 2,5 W / 6 switches max. 5 W
EGS C-R (positively driven relay contacts)	5 VAC ... 230 VAC 5 mA ... 500 mA 5 VDC ... 30 VDC 5 mA ... 500 mA 5 VDC ... 230 VDC 5 mA ... 180 mA
Mechanical relay life time	>10.000.000 operations
Time between 2 switching operations required of a relay	≥ 135 ms
Switching accuracy	See chapter 6.4.2
Connection	Screw-type terminal 0,25 mm ² - 1,5 mm ²
Connecting diagram	PN164-420e, PN164-421e (see chapter 10.2)

Install a back-up fuse (max. 2A) to protect the relay contacts against overcurrent's.

6.4.2 Switching accuracy

The switching accuracy (max. switching errors) Δn is made up of:

- Switching time T_{Sw} : ≤ 10 ms
- Measuring accuracy ΔF (Error in the determination of speed): ≤ 2 %
- Measuring angle ϕ : approx. 0,25°

The following formula arises from it:

$$\Delta n = \sqrt{n_0^2 + \frac{\alpha \cdot \phi}{3}} + \alpha \cdot \frac{T_{Sw}}{1000} + \Delta F \cdot n_0 - n_0$$

Δn : max. switching failure [rpm]
 n_0 : switching point [rpm]
 α : acceleration [rpm / s]
 ϕ : measuring angle [°]
 T_{Sw} : switching time [ms]

	<p>WARNING!</p> <ul style="list-style-type: none"> • Overvoltage category III: In case of a mixed population between adjacent relay outputs with SELV/PELV and mains voltage a double / reinforced insulation can be stated up to 150 V AC or 212 V DC, assuming a maximum altitude of 2000 m. An appropriate fixing of the wires is necessary to avoid cross faults between the different voltage areas. For higher voltages it must be ensured that sufficient spacing is maintained, e.g. by leaving one relay output in-between unconnected. • At a height of 2000 m - 3000 m the max. switching voltage is 150 VAC or 212 VDC.
---	--

6.5 Error switch

It is possible to assign the error switch function to a single or several speed and position switches as required using the configuration software (see configuration manual). The switch is closed when no errors occur during operations.

A detailed description of parameter assignments is provided in a separate configuration manual.

	<p>During error-free start up of the UOC 40 / ERC 40 the fault switch closes approx. 100 ms before the fault and status output reaches high level.</p>
---	--

6.6 PROFIBUS module (UOC 40 only)

The Profibus-module EPF-C can be configured to the Profibus® profiles CLASS 1 (Huebner 1.0), with parameterization of the count direction, or CLASS 2 (Huebner 2.0), with the additional setting of the resolution in units/turn and the total measuring range.

The profiles Huebner 2.1 and Huebner 2.2 are also available. These enable the following additional functions:

- Expanded scaling function
- Setting of code sequence (count direction), preset and automatic scaling (teach-in) during online operation in commissioning mode.
- Limit switch function
- Velocity/speed output

These functions shift a portion of the computing effort from the Profibus® master to the UOC 40, thus reducing the load on the system as a whole. However, if these extra functions are not needed, then it makes sense to keep the parameterization simple, by using a CLASS 1 or CLASS 2 profile.

UOC 40 / ERC 40

Operating and Assembly Instructions

6.6.1 Profibus profile for the encoder

The Profibus module EPF-C can be configured and parameterized to the following profiles, as a multiturn or singleturn encoder:

Encoder profile	Parameterization options
HUEBNER 1.0 Single / Multiturn (CLASS 1)	Count direction
HUEBNER 2.0 Single / Multiturn (CLASS 2)	Count direction Switch HUEBNER 2.0 functions on/off Switch scaling functions on/off Resolution / revolution Total resolution
HUEBNER 2.1 Single / Multiturn	As for HUEBNER 2.0, additionally with: Required no. of measuring units, Required resolution in units per - revolution - max. total resolution - physical pulses Switch commissioning mode on/off Use preset value in online operation Determine gearing factor (scaling) Switch lower limit switch on/off Lower limit switch (position) Switch upper limit switch on/off Upper limit switch (position)
HUEBNER 2:2 Single / Multiturn	As for HUEBNER 2.1, with additional velocity/speed output

Note:

The encoder can be operated in HUEBNER 1.0, HUEBNER 2.0, HUEBNER 2.1 or HUEBNER 2.2, regardless of whether a CLASS 1 or CLASS 2 master has been selected.

6.6.2 Electrical data PROFIBUS

Detail	Value
Supply voltage	is supplied by ECU C
Additional module power consumption EPF	max. 1,5 W
Resolution Singelturn	max. 12 Bit (4096 steps/revolution)
Resolution Multiturn	max. 12 Bit (4096 revolutions)
Data Interface	RS 485 isolated from the encoder electronic
Baud rate	9,6 kbit/s...12 Mbit/s
Addressing	1 – 99, settable via rotary switch
Bus Termination	switchable
Coding	binary
Programmable functions	
Multiturn or Singleturn	
CLASS 1 Mode	counting direction
CLASS 2 Mode	counting direction resolution/revolution total resolution scaling
Mode 2.1	CLASS 2 mode additional end switch function
Mode 2.2	CLASS 2 mode additional end switch function and velocity output
Connection diagram	PN164-411 (see chapter 10.2)

UOC 40 / ERC 40

Operating and Assembly Instructions

6.6.3 LED display for error and status messages

Two LED's, one red and one green are built into the cover of the terminal box. They are used to indicate errors and the momentary status of the encoder. Each one of the LED's can have the state; OFF, BLINKING or ON. This allows 9 possible combinations, of which 6 are used as follows:

LED display in the terminal box cover		
Red LED	Green LED	Error indication / encoder status
off	off	No supply voltage
on	blinking	Coding and / or parameterization error. Possible cause: Data length too large, total resolution is too high.
on	off	Encoder has not received data for a longer period from Master
blinking	on	Encoder registers data on the bus, but this is not addressed (for example, the wrong encoder address is set in the terminal box cover).
off	blinking	Commissioning mode in Data-Exchange-Mode
off	on	Normal operation mode in Data-Exchange-Mode

A detailed description of the parameterization is given in the separate configuration manual.

7 Inspections

7.1 Safety instructions

	<p>NOTES/PERSONNEL!</p> <p>Skilled technical staff only are permitted to inspect the UOC 40 / ERC 40 and its installation.</p> <p>Observe the safety instructions contained in chapter 2 when inspecting or working on the UOC 40 / ERC 40!</p>
---	---

7.2 Maintenance information

The UOC 40 / ERC 40 is maintenance-free. However, to guarantee optimum fault-free operations we recommend that you carry out the following inspections.

The inspection work described in this section must be carried out by skilled technical staff only. We remind you of your obligation to observe and adhere to all operating and owner-relevant accident prevention regulations, laws regarding the safeguarding of machinery and plant as well as application and country-specific regulations, laws and standards.

7.3 Inspection schedule

	<p>NOTES!</p> <p>No interventions other than the cyclic tests described in the test schedule are necessary on the UOC 40 / ERC 40. Any intervention on the UOC 40 / ERC 40 renders all guarantee claims null and void!</p>
--	---

Interval	Inspections
Yearly	Inspect the coupling for damage and ensure it is free of play
	Ensure the fastening screws are properly tightened
	Ensure cable connections and connection terminals are properly tightened
	Ensure the blanking plugs are sealing properly
	Check, and if necessary restore, the legibility of labels and nameplates
	Test the switch (See chapter switch test in the separate configuration manual).
After approx. 16 000 – 20 000 hours of operation or higher levels of continuous load	Check deep groove ball bearings for noise, running smoothly.

UOC 40 / ERC 40

Operating and Assembly Instructions

7.4 Fault table

Faults	Possible cause	Remedy
Failure output Low	No supply voltage <u>Control</u> : LEDs in terminal box does not shine	Check connection cable and supply voltage
	A failure was recognised	Start the US42Pro software and then connect to the device. The error is displayed according to error table (see document configuration manual). Corresponding remedial measures are to be initiated. <u>Internal errors</u> are e.g. triggered by deviations of the device-internal program sequence. For more information, see the document configuration manual "Error Handling".
Moisture in the terminal box	Soiled gasket or seal surfaces of terminal box cover	Clean gasket of terminal box cover and seal surfaces
	Damaged gasket of terminal box cover	Replace O-ring of terminal box cover
	Cable gland/blanking plug not tightened	Tighten cable gland/blanking plug
	Unsuitable cable for cable gland	Use suitable cable and cable glands
Contact Hübner-Service (see page 2) if none of the remedies listed above provides a solution!		

7.5 Checklist

We recommend that you print out and work through the checklist for commissioning, replacing the measuring system and when changing the parameterization of a previously accepted system and store it as part of the overall system documentation.

Documentation reason		Date	Edited	Checked
Sub-item	To note	Can be found under		Yes
Present user manual has been read and understood.				<input type="checkbox"/>
Check that the UOC 40 / ERC 40 can be used for the present automation task on the basis of the specified safety requirements.	Intended use	chapter 2.3		<input type="checkbox"/>
	Compliance with all technical data	chapter 5.3		<input type="checkbox"/>
Fulfilment of the installation requirements defined in the user manual	Safe mechanical fixing of the UOC 40 / ERC 40 and safe positive connection of the driving shaft with the UOC 40 / ERC 40	chapter 3		<input type="checkbox"/>
Requirements for the supply voltage	The power supply used must meet the requirements of SELV/PELV (IEC 60364-4-41:2005).	chapter 6.1.1		<input type="checkbox"/>
Correct PROFIBUS/PROFINET installation	Compliance of the international standards valid for PROFIBUS or the directives specified by the PROFIBUS User Organization	chapter 6.6		<input type="checkbox"/>
Preset Adjustment Function	The preset adjustment function may only be executed when the affected axis is stationary. It must be ensured that the preset adjustment function cannot be inadvertently triggered. After execution of the preset adjustment function the new position must be checked before restarting.	chapter Preset Adjustment in the separate configuration manual		<input type="checkbox"/>
Device replacement	It must be ensured that the new device corresponds to the replaced device. All affected safety functions must be checked.	chapter 3.5.2		<input type="checkbox"/>

UOC 40 / ERC 40

Operating and Assembly Instructions

8 Transport, packaging and storage

8.1 Safety information concerning transport

	<p>CAUTION! Material damage caused by improper transport! Observe the symbols and information on the packaging: Do not throw - risk of breakage Keep dry Do not expose to heat above 40 °C or direct sunlight.</p>
---	--

8.2 Goods inward inspection

Check the delivery immediately upon receipt for transit damage or short delivery. Inform the carrier immediately on receipt if you determine that damage has occurred during transit (take photos as proof).

8.3 Packaging (disposal)

The packaging is not taken back; dispose of according to the respective valid statutory provisions and local regulations.

8.4 Storing packages (devices)

	<p>Keep dry! Keep packages dry and free from dust; protect from moisture.</p>
--	--

	<p>Protect against heat! Protect packages from heat above 40 °C and direct sunlight.</p>
---	---

If you intend to store the device for a longer period of time (> 6 months) we recommend you use protective packaging (with desiccant).

	<p>NOTES! Turn the shaft of the UOC 40 / ERC 40 every 6 month to prevent the bearing grease solidifying.</p>
---	---

8.5 Returning devices (repairs/goodwill/warranty)

The devices which have got into contact with radioactive radiation or radioactive materials will not be taken back.

The devices which have got into contact with possibly noxious chemical or biological substances must be decontaminated before the return.

They must also be accompanied by a safety clearance certificate.

8.6 Disposal

The manufacturer is not obligated to take back electronics waste.

The UOC 40 / ERC 40 consists of hybrid components, and in part must be disposed of as special waste (electronic scrap) according to country-specific legislation.

Local municipal authorities or specialized disposal companies provide information on environmentally responsible disposal.

9 Accessories

The scope of supply of the UOC 40 / ERC 40 includes:

- The Operating and Assembly Instructions,
- configuration instructions,
the Software & Support CD and the USB programming cable, which can also be requested separately.

9.1 Spare parts

Description
Software & Support CD
Operating and Assembly Instructions
ECU configuration instructions
PROFIBUS configuration instructions
USB programming cable
O-ring 84x2 to seal terminal box
Pressure compensation element

UOC 40 / ERC 40

Operating and Assembly Instructions

9.2 Coupling

We recommend our zero-backlash, torsion-resistant coupling HK5 to attach the UOC 40 / ERC 40.

The coupling meets the following requirements

Description		Value	
torque		5 Nm	
max. speed		10000 rpm	
mounting accuracy	<u>HK 5 / HKI 5:</u>	axial offset:	± 1 mm
		angular:	0,5°
	<u>HKD 5 / HKDI 5:</u>	axial offset:	$\pm 1,5$ mm
		radial offset:	$\pm 0,5$ mm

For further information please do not hesitate to contact our sales department.

10 Documents

10.1 Dimension drawing

HM 17 M 111899a

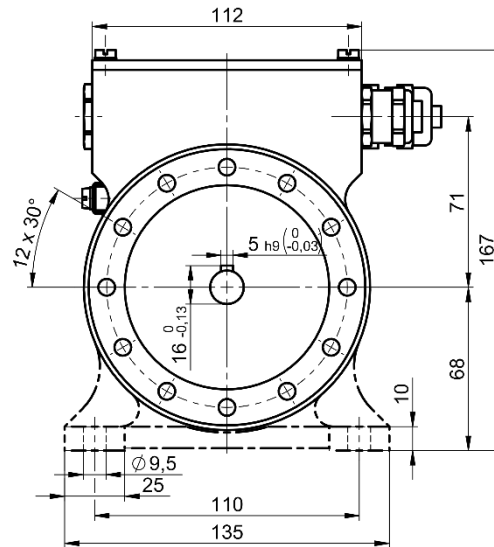

Fig. 10-1 – front view

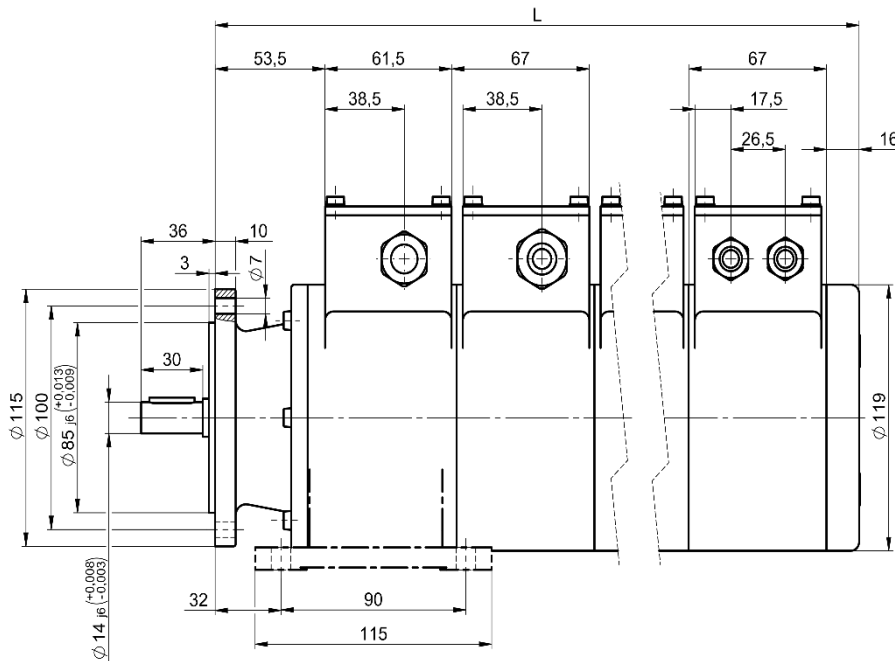

Fig. 10-2 – side view

Modulanzahl	L
X1	134
X2	201
X3	268
X4	335
X5	402

UOC 40 / ERC 40

Operating and Assembly Instructions

10.2 Connection Diagrams



NOTES!

The connection diagrams are depicted on the respective terminal box cover.
No shielded connection cables are necessary for the switching outputs.

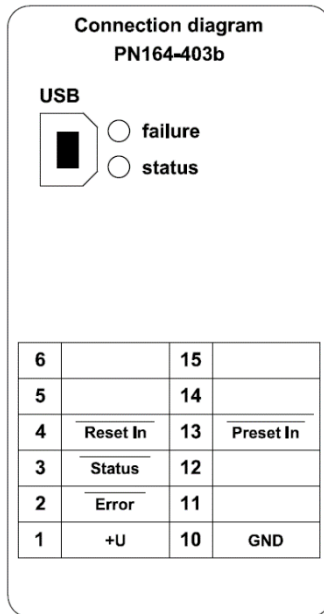

The shield of the signal cable is connected directly to the housing via the EMC cable gland.

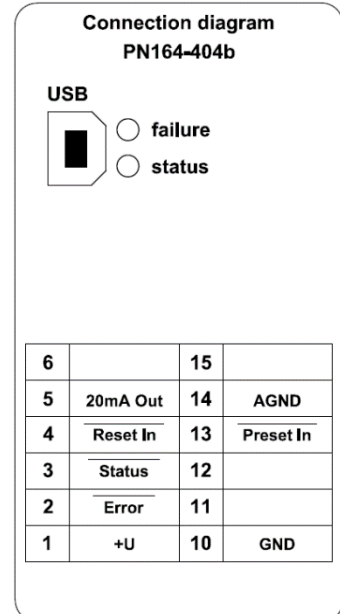

Connection diagram ECU C PN164-403b

Connection diagram ECU C-I Option I (current output) PN164-404b

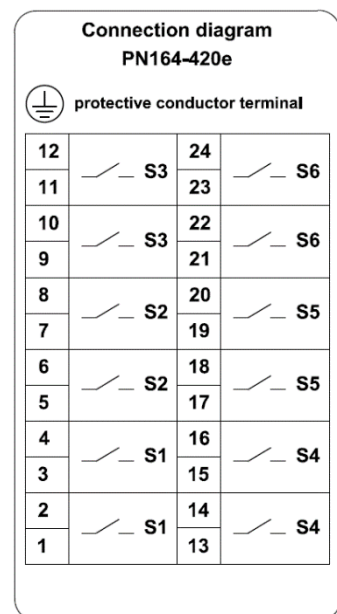
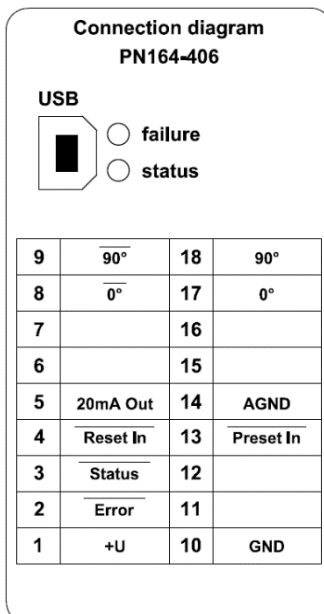

Connection diagram ECU C-G Option G (incremental output) PN164-406

Connection diagram switching module, twice PN164-420e

UOC 40 / ERC 40

Operating and Assembly Instructions

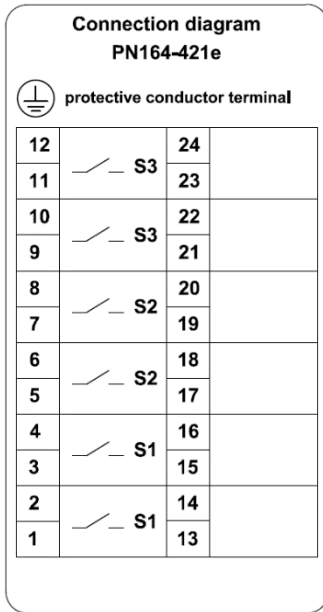

Connection diagram
switching module, single

PN164-421e

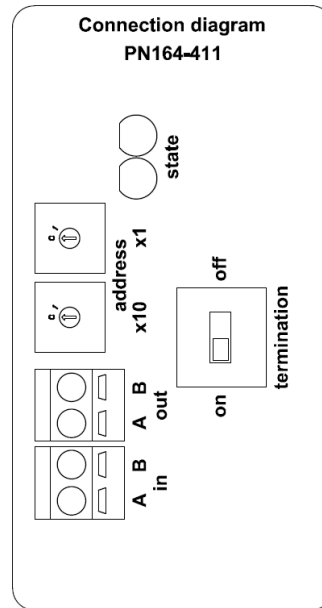

Connection diagram
PROFIBUS

PN164-411